

# Desalination Demonstration Report for Buena Vista Water Storage District

---

## **Buena Vista Water Storage District**

Client Representative **Dan Bartel**

## **Boyle Engineering Corporation**

Project Manager **Christopher J. Martin, PE**

Project Engineer **Asabi E. Goodman, EIT**

Prepared in cooperation with the California Department of Water Resources, the Kern County Water Agency, and the University of California at Los Angeles.

December 2003

*Disclaimer: This report summarizes the results of studies, which investigate the performance and fouling behavior of low-pressure reverse osmosis and nanofiltration membranes for treating subsurface agricultural drainage water for the California Department of Water Resources. Publication of any finding or recommendations in this report should not be construed as representing the concurrence of the Department. Also, mention of trade names or commercial products does not constitute Department endorsement or recommendation.*

# Table of Contents

---

|  |    |
|--|----|
| Executive Summary .....                    | 5  |
| Introduction.....                          | 8  |
| Definition of Terms.....                   | 8  |
| Participants.....                          | 9  |
| Study Objectives .....                     | 9  |
| Testing Protocol .....                     | 10 |
| Analytical Sampling and Systems.....       | 10 |
| Schedule of Operation.....                 | 12 |
| Plant Location and Layout.....             | 13 |
| Feedwater Quality.....                     | 17 |
| Feedwater Sources .....                    | 17 |
| Piezometers.....                           | 17 |
| Feedwater Quality .....                    | 20 |
| Shallow Water Characteristics.....         | 22 |
| Well Water Characteristics .....           | 25 |
| Treatment Process.....                     | 26 |
| Pretreatment Filtration System.....        | 26 |
| Reverse Osmosis System .....               | 28 |
| Daily Operator Tasks .....                 | 28 |
| RO Plant Performance Evaluation.....       | 31 |
| Filter Performance Data.....               | 31 |
| RO Performance Data .....                  | 31 |
| Normalized Flux Variations:.....           | 31 |
| Laboratory Water Quality Analysis .....    | 41 |
| Evaluating RO Membrane Salt Rejection..... | 41 |

|  |     |
|--|-----|
| Total Organic Carbon Results.....  | 45  |
| Costs.....   | 47  |
| Summary.....   | 53  |
| Future Study.....  | 53  |
| Evaporation Ponds.....   | 54  |
| Deep Well Injection.....   | 55  |
| Disposal to a Body of Water.....   | 56  |
| Enhanced Recovery.....   | 56  |
| Appendix A – 2000 Demonstration Plant Data.....                                  | 60  |
| Appendix B – Laboratory Analytical Data.....                                     | 73  |
| Appendix C – Initial RO Projection.....  | 82  |
| Appendix D – Year 2002 Filter Performance Data.....                              | 90  |
| Appendix E – RO System Operating Data.....                                       | 111 |
| Appendix F – Conceptual Layout Designs for Various<br>Production Flow Rates..... | 115 |
| Appendix G – Piezometer Data: Contour Maps.....                                  | 120 |
| Appendix H – KOCH Membrane Specifications.....                                   | 125 |
| Appendix I – Shallow Well Diagrams.....  | 130 |

# Executive Summary

The area served by the Buena Vista Water Storage District (BVWSD), as well as other areas within the San Joaquin Valley, consists primarily of irrigated farmland. In order to prevent the dissolved salts in the irrigation water from concentrating in the root zone, it is necessary to apply irrigation water in excess of the crops' consumptive use to carry the salts below the crops' root zones. A semi-permeable clay layer about 100 feet to 200 feet below ground surface limits the depth to which the water can percolate resulting in a shallow, saline groundwater aquifer.

During the irrigation season, the water level rises to within a few feet of the ground surface. Evaporation of some of the water, adjacent saline subsurface flow, and long-term historical irrigation patterns have caused the shallow saline groundwater to increase the soil salinity in the crop root zones resulting in lower crop yields. This has forced some and is threatening to force more land out of agricultural production.

On-farm tile drainage systems are used in some areas of the San Joaquin Valley to keep the saline shallow groundwater below the crop root zone. Disposal of the collected drainage water is a major problem that must be addressed.

The drainage water, however, can also be considered as a potential water source. Desalting of the drainage water is necessary to make the water usable. A reverse osmosis (RO) desalination demonstration plant was implemented to demonstrate the feasibility of desalting the drainage water and converting what is now a liability into an asset.

The objectives and results of the RO desalination demonstration plant are summarized below:

| OBJECTIVE  | RESULT   |
|--|--|
| 1. Demonstrate the ability of commercially available reverse osmosis (RO) membranes to treat agricultural drainage water | Removed approximately 97% of dissolved solids and obtained a 75% water recovery. |

| OBJECTIVE  | RESULT  |
|--|---|
| 2. Evaluate pretreatment methods to determine their effectiveness in providing suitable supply (feed water) for the RO system.                 | Both direct multi-media and sand filters as well as alum (coagulant) were used to pre-treat the feed water. Both filters successfully produced the desired RO feed water quality. |
| 3. Evaluate the quality of water that can be expected from a typical tile drain system.  | The water from the tile drain system proved to be high in total dissolved solids (TDS) concentration as expected, but also contained algae and suspended solids.                  |
| 4. Demonstrate the level of effort necessary for operating a RO system designed to treat agricultural drainage water.                          | It was demonstrated that one operator could operate the system.   |
| 5. Provide data to support permitting of the construction and operation of a full-scale RO system treating agricultural drainage water.        | Water quality data gained from the RO demonstration process will help to support the necessary permitting.  |
| 6. Provide data supporting potential marketing efforts for new water supplies produced by treating agricultural drainage water.                | Water quality data gained from the RO demonstration process will help to support the potential for marketing.   |
| 7. Provide data supporting development of cost opinions for full-scale treatment.  | Cost estimates to support full-scale implementation for irrigation supply are presented in <b>Tables 6</b> and <b>7</b> .   |
| 8. Determine the appropriate pretreatment filtration system necessary to facilitate maximum RO performance and RO membrane operation lifetime. | Data showed that either multimedia or sand filters would perform adequately with standard chemical coagulant.   |
| 9. Determine the effectiveness of shallow wells for reclaiming land impacted by drainage.  | The shallow wells lowered the shallow saline water table elevation and provided a more reliable raw water supply for the demonstration project                                    |

This RO demonstration project, conducted during the growing seasons of 2000 and 2002, evaluated the possibility of desalting the shallow

saline groundwater recovered by a tile drain system and two shallow wells to produce an irrigation water supply. The drainage water was treated using RO resulting in as much as 97% removal of the dissolved solids from the feed water. About 75% of the RO feedwater was recovered as potentially usable water. The remaining water, containing the dissolved solids removed from the raw water, required disposal.

The average total dissolved solids concentration in the desalted water and the shallow groundwater were 230 mg/L and 4,000 mg/L, respectively.

Based on the water quality analyses obtained from both the 2000 and 2002 irrigation seasons, the desalted water can be used for irrigation. Data obtained demonstrated that desalted water of this quality could be produced on a consistent basis using RO to provide a usable water supply.

**Table ES-1** summarizes the range of capital and O&M costs for full-scale treatment at varying productions rates.

**Table ES-1. Cost Estimates for Full Scale Treatment**

| Production (MGD)             | 1     | 2     | 5      | 10     |
|------------------------------|-------|-------|--------|--------|
| Capital Cost (M\$)           | \$2.9 | \$5.0 | \$10.6 | \$21.3 |
| O&M Cost (M\$)               | \$0.4 | \$0.6 | \$1.6  | \$3.1  |
| Water Cost (\$/AFY Produced) | \$618 | \$490 | \$452  | \$443  |



**Figure ES-2. Buena Vista RO Desalination Demonstration Pilot Trailer**

# Introduction

---

Saline agricultural drainage water within the Buena Vista Water Storage District is accumulating in shallow aquifers located below productive farmland. This saline water has risen to elevations where it increases the soil salinity in crop root zones resulting in reduced crop productivity and in some areas of the District, lands have been taken out of production because of the high saline groundwater table.

A reverse osmosis pilot plant was constructed to demonstrate the feasibility of desalting saline irrigation drainage water for use as a water supply for agricultural or municipal use. The demonstration plant was constructed in the Buena Vista Water Storage District northwest of Bakersfield, California. The plant operated during the irrigation seasons of 2000 and 2002.

Initially, the saline groundwater used as feedwater for the RO demonstration plant was collected by a tile drain system that was installed in November 1999. The water flowed into a sump. It was then pumped to the plant.

In 2001, however, the tile drain system did not produce enough water to operate the RO demonstration plant. Therefore, two shallow wells were drilled in December of 2001 to provide a more reliable feedwater source to the RO demonstration unit.

---

## Definition of Terms

- Permeate: desalted water exiting RO process
- Concentrate: wastewater exiting RO process
- Filtrate: water exiting pretreatment filters
- Feed: source water entering pretreatment filters (saline drainage water)
- Recovery: percentage of feed water recovered as permeate



---

## Participants

A number of organizations participated in the preparation and operation of the demonstration plant.

The Buena Vista Water Storage District served as the contractor and the project administrator for the California Department of Water Resources (DWR), the main project sponsor. Dave Bloemhof of Bloemhof Farms provided the RO demonstration site. Supplemental funding was provided by:

- Kern County Water Agency
- Lost Hills Water Storage District
- Semitropic Water Storage District
- Wheeler Ridge – Maricopa Water Storage District

Boyle Engineering Corporation provided engineering services, the RO demonstration plant, and plant operators. The sampling and analysis plan, engineering services, laboratory services, and pretreatment filters were provided by DWR. Technical support was provided by UCLA and field support was provided by BVWSD staff as needed from time to time.

---

## Study Objectives

The study was intended to meet several objectives:

1. Demonstrate the ability of commercially available RO membranes to treat agricultural drainage water.
2. Evaluate pretreatment methods to determine their effectiveness in providing suitable feed water for the RO system.
3. Evaluate the quality of water that can be expected from a tile drain system.
4. Demonstrate the level of effort necessary for operating a RO system designed to treat agricultural drainage water.
5. Provide data to support permitting of the construction and operation of a full-scale RO system treating agricultural drainage water.

6. Provide data supporting potential marketing efforts for new water supplies created by desalting agricultural drainage water.
7. Provide data supporting development of cost opinions for full-scale treatment.
8. Determine an appropriate pretreatment filtration system necessary to facilitate maximum RO performance and RO membrane operation lifetime.
9. Demonstrate the effectiveness of shallow wells as a feedwater to an RO plant and determine impact on ground water levels.

---

## Testing Protocol

The following demonstration test protocol was developed to provide evidence that the objectives listed above were attained.

- **Particle removal verification:** The feed water Silt Density Index (SDI) should be below 3.0. The performance of both pretreatment filtration systems indicated that this requirement could be met on a consistent basis.
- **Fouling constituent verification:** Analyses of the feed and filtrate stream samples were taken to show that potential RO membrane fouling constituent concentrations were at levels which do not negatively impact membrane life and performance. Based on the analytical data, RO membrane fouling will occur at acceptable rates as long as the proper amounts of scale inhibitor and acid are injected into the RO feed stream.
- **Product water quality verification:** Analyses of the permeate indicated that RO is capable of producing water that can be utilized for potable or agricultural use.

---

## Analytical Sampling and Systems

**Table 1** is an outline of the analyses that were performed on a daily, weekly and monthly basis. The onsite operator performed daily analyses and DWR's Bryte Laboratory performed the weekly and monthly analyses.

**Table 1. Analytical Schedule**

| Analysis   | Sample Location |        |         |                    |        |         |          |        |         |             |        |         |
|------------|-----------------|--------|---------|--------------------|--------|---------|----------|--------|---------|-------------|--------|---------|
|            | Feed            |        |         | Filtrate (2 units) |        |         | Permeate |        |         | Concentrate |        |         |
|            | Daily           | Weekly | Monthly | Daily              | Weekly | Monthly | Daily    | Weekly | Monthly | Daily       | Weekly | Monthly |
| Turbidity  | X               | X      | X       | X                  | X      | X       |          | X      | X       |             | X      | X       |
| EC         | X               | X      | X       |                    | X      | X       | X        | X      | X       | X           | X      | X       |
| Temp.      |                 |        |         | X                  |        |         | X        |        |         |             |        |         |
| TDS        |                 | X      | X       |                    | X      | X       |          | X      | X       |             | X      | X       |
| Calcium    |                 | X      | X       |                    | X      | X       |          | X      | X       |             |        | X       |
| Magnesium  |                 | X      | X       |                    | X      | X       |          | X      | X       |             |        | X       |
| Sodium     |                 | X      | X       |                    | X      | X       |          | X      | X       |             |        | X       |
| Carbonate* |                 | X      | X       |                    | X      | X       |          | X      | X       |             |        | X       |
| Bicarb.*   |                 | X      | X       |                    | X      | X       |          | X      | X       |             |        | X       |
| Chloride   |                 |        | X       |                    |        | X       |          |        | X       |             |        | X       |
| Sulfate    |                 |        | X       |                    |        | X       |          |        | X       |             |        | X       |
| Boron      |                 |        | X       |                    |        | X       |          |        | X       |             |        | X       |
| SiO2       |                 |        | X       |                    |        | X       |          |        | X       |             |        | X       |
| Barium     |                 |        | X       |                    |        | X       |          |        | X       |             |        | X       |
| Strontium  |                 |        | X       |                    |        | X       |          |        | X       |             |        | X       |
| Selenium   |                 |        | X       |                    |        |         |          |        | X       |             |        | X       |
| TSS        |                 |        | X       |                    |        | X       |          |        |         |             |        |         |
| TOC        |                 |        | X       |                    |        | X       |          |        | X       |             |        | X       |
| UV254      |                 |        | X       |                    |        | X       |          |        | X       |             |        | X       |
| SDI        |                 |        |         | X                  |        |         |          |        |         |             |        |         |

Other analyses as needed: pH, fluoride, iron, nitrate, nitrite, orthophosphate, potassium and DOC

---

## Schedule of Operation

Initially, the desalination demonstration project was to operate throughout the 2000 and 2001 irrigation seasons. However, due to the lack of water from the tile drain system, the project was not able to maintain sustained operation in 2001. The project was extended for a year, and modified by the inclusion of two shallow wells to provide a more reliable drainage water supply. These wells were completed in December 2001, and RO demonstration continued through the 2002 irrigation season.

The data in this report reflects the RO demonstration plant's operation from June 27 to September 13, 2000 and from April 1 to December 4, 2002. The data focuses mainly on the year 2002 irrigation season when sustained RO operations were maintained.

Operation during the previous years is described in the following reports:

- Pilot Design Report for Buena Vista Water Storage District, June 2000
- Desalination Pilot Report for Buena Vista Water Storage District, December 2000
- Phase 2 Demonstration Project Report for Buena Vista Water Storage District, January 2002

# Plant Location and Layout

During the two irrigation seasons the demonstration plant operated, two sources supplied feed water to the demonstration plant. The first source, used during the year 2000, was from a tile drain system. David Bloemhof, the owner of Bloemhof Farms, where the demonstration plant was located, installed this tile drain system.

A location map is provided in **Figure 1, Demonstration Plant Location Map**.

**Figure 2, Tile Drain Layout**, shows the tile drain system and demonstration plant site in relation to the drainage problem areas of Bloemhof Farms.

The second source of feed water, used during 2002, was two shallow wells drilled in December of 2001. **Figure 3, Well Location Map**, shows the locations of the two wells and the shallow piezometer wells in reference to the RO demonstration plant. The differences in water quality of each source are discussed in the next section.

The demonstration plant was located adjacent to a Bloemhof Farms' drainage water sump. Water flowed into the sump from the tile drain system and was pumped to the RO prefiltration equipment. Following the RO desalting process, both the permeate and the concentrate were returned to the drainage sump.

In addition to the treatment equipment, an office trailer was situated at the site to serve as a facility for the operator to perform analytical tests, and to house the monitoring computer.

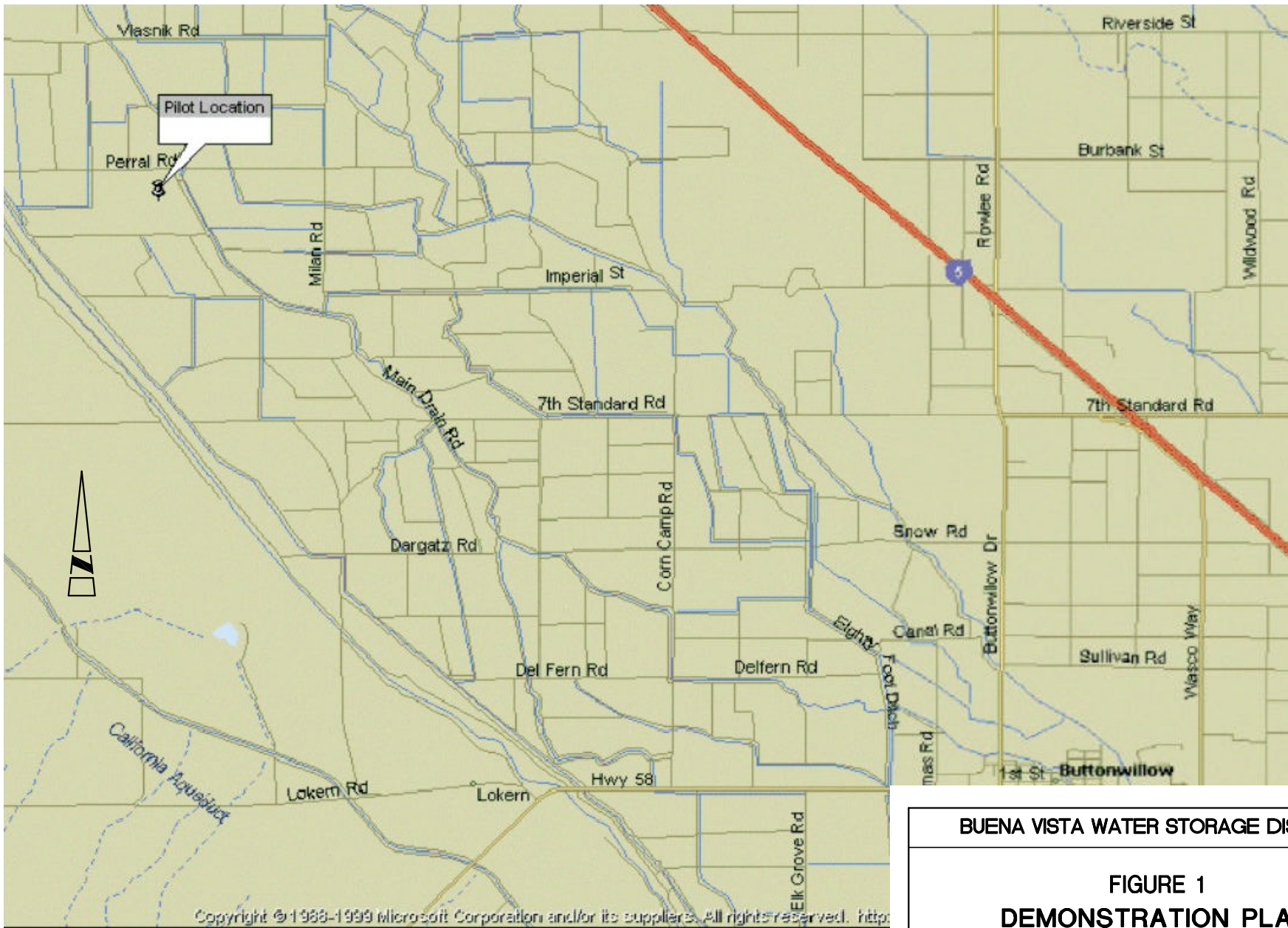

**BUENA VISTA WATER STORAGE DISTRICT**

**FIGURE 1  
DEMONSTRATION PLANT  
LOCATION MAP**

*BOYLE ENGINEERING CORPORATION*

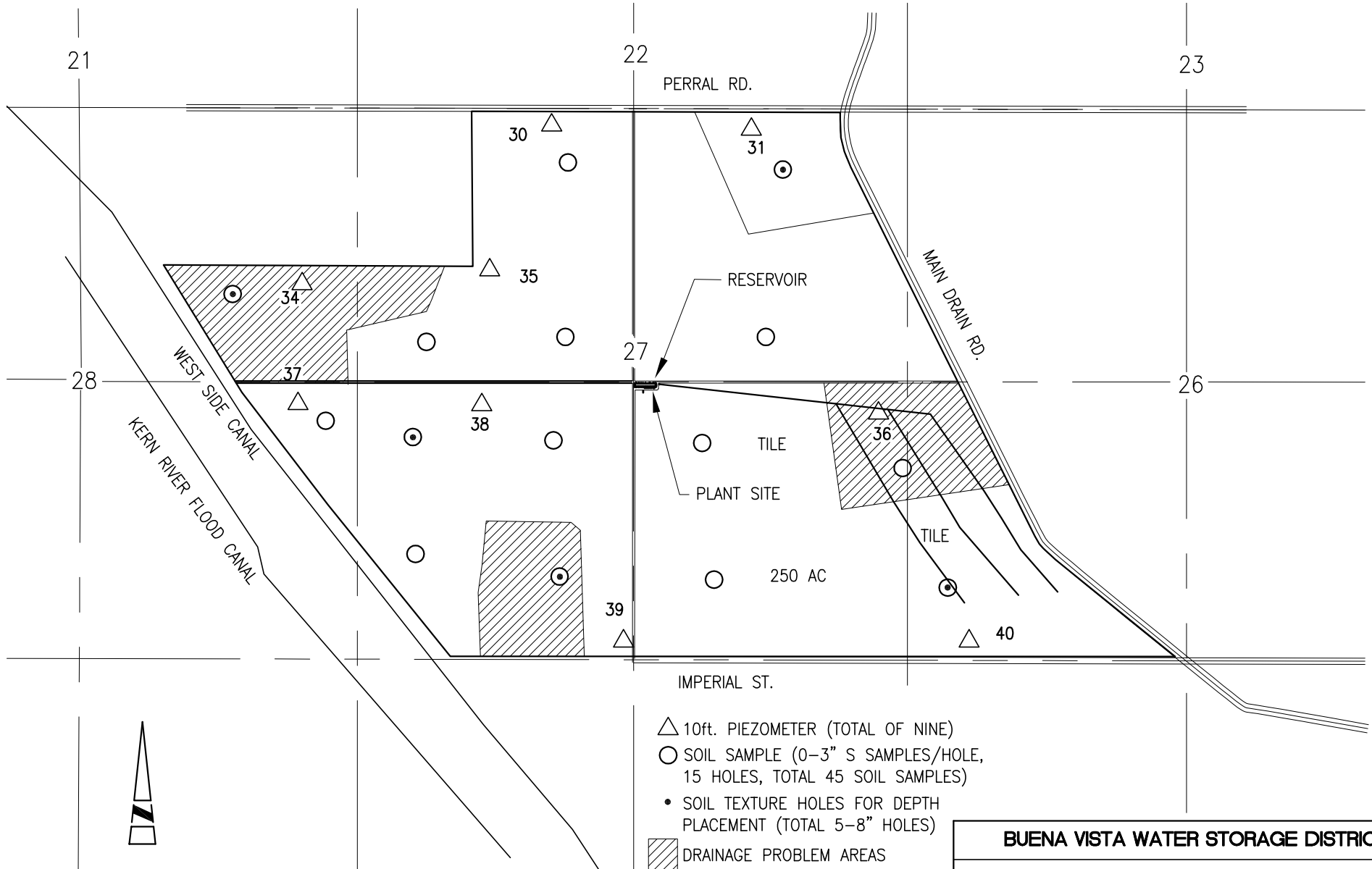

- △ 10ft. PIEZOMETER (TOTAL OF NINE)
- SOIL SAMPLE (0-3" S SAMPLES/HOLE, 15 HOLES, TOTAL 45 SOIL SAMPLES)
- SOIL TEXTURE HOLES FOR DEPTH PLACEMENT (TOTAL 5-8" HOLES)
- ▨ DRAINAGE PROBLEM AREAS

**BUENA VISTA WATER STORAGE DISTRICT**

**FIGURE 2  
TILE DRAIN LAYOUT**

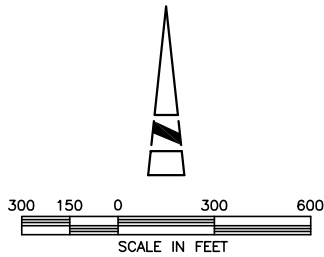

LEGEND

- ⊕ PEIZOMETER
- BRACKISH WATER WELL

BUENA VISTA WATER STORAGE DISTRICT

FIGURE 3

WELL LOCATION MAP

BOYLE ENGINEERING CORPORATION



# Feedwater Quality

---

## Feedwater Sources

Two sources supplied feed water to the plant. The first source referred hereinafter as *tile drain water* was used during 2000. Tile drain water, as the name implies, came from a tile drain system constructed beneath the root zone of the crops. Water that percolates through the crop root zone is collected by the tile drain system and is emptied into a sump. A sump pump delivers the drainage water to the RO demonstration plant. Refer to **Figure 2** for the location of the tile drain system and the RO demonstration plant.

The second source, hereinafter referred to as *well water* was used in 2002. Well water was supplied by two wells drilled after flows too low to operate the demonstration plant were experienced in 2001 with tile drain water. These wells pump water from the same aquifer as the tile drain system but from a deeper depth so that fluctuations in groundwater depth have less impact than with a tile drain system. The depth of the two wells is about 80 feet. The two wells are referred to hereinafter as the North Well and the South Well (100 gpm each).

### Piezometers

In 2002, five piezometers were installed to monitor the effects on the groundwater elevation resulting from operation of the North and South Wells. The piezometers are located as shown on **Figure 3**:

- #1, #2, and #3 (between the North Well and the South Well);
- #4 (north of the North Well); and,
- #5 (south of the South Well).

These five piezometers supplemented five existing piezometers:

- #30 (northwest of the North Well);
- #31 (northeast of the North Well);
- #35 (southwest of the South Well);
- #36 (southeast of the South Well); and,
- #38 (southeast of the South Well).

**Figures G-1 through G-4**, located in **Appendix G**, show surface and groundwater elevation contours for the September 2001, December 2001, September 2002, and December 2002. The North and South Wells were drilled in December 2001 and operated during 2002.

**Table 2** shows the depths to groundwater for piezometers #30, #31, #35, and #36 and for the North and South Wells based on the information in **Figures G-1 through G-4**.

**Table 2**

| <b>Depth to Groundwater (feet)</b> |                    |            |            |            |                              |
|------------------------------------|--------------------|------------|------------|------------|------------------------------|
| <b>Date</b>                        | <b>Piezometers</b> |            |            |            | <b>North and South Wells</b> |
|                                    | <b>#30</b>         | <b>#31</b> | <b>#35</b> | <b>#36</b> |                              |
| <b>9/01</b>                        | <b>8</b>           | <b>8</b>   | <b>7</b>   | <b>8</b>   | <b>6</b>                     |
| <b>12/01</b>                       | <b>7</b>           | <b>9</b>   | <b>6</b>   | <b>9</b>   | <b>6-7</b>                   |
| <b>9/02</b>                        | <b>10</b>          | <b>8</b>   | <b>9</b>   | <b>7</b>   | <b>13-15</b>                 |
| <b>12/-2</b>                       | <b>10</b>          | <b>10</b>  | <b>11</b>  | <b>10</b>  | <b>12-13</b>                 |

**Figure 4** shows the water surface elevations recorded at piezometer #31 for the period June 1999 through December 2002. In addition, the figures shows the water surface elevations measured at the North and South Wells during the months in 2002 when the demonstration plant was operated.

Figure 4. Change in Groundwater Elevation Through 2002

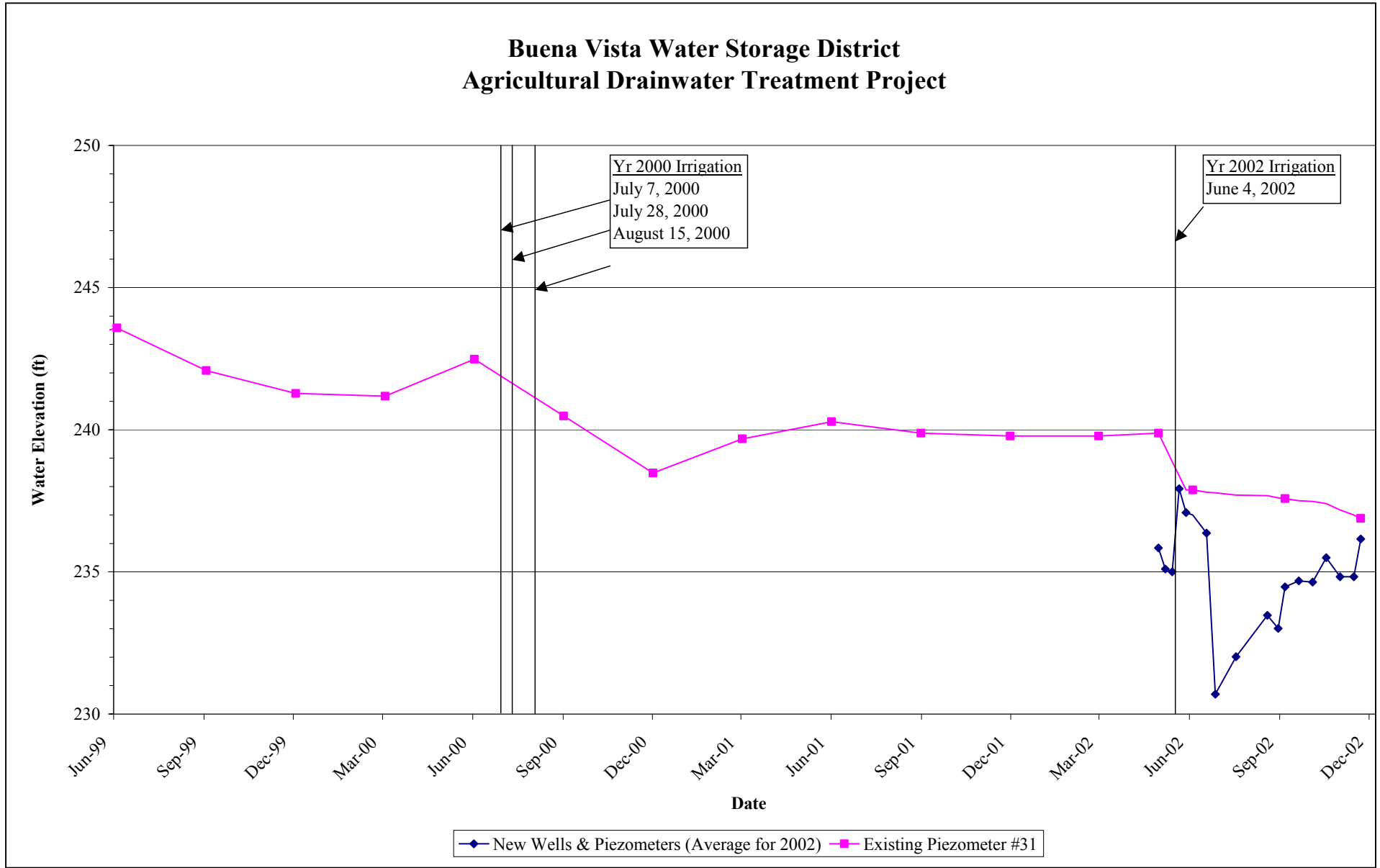

---

## Feedwater Quality

Feedwater quality affects the performance of any treatment process including RO. The more important quality parameters of RO feedwater include total dissolved solids, electrical conductivity, total suspended solids, silt density index, and pH.

- **Total Dissolved Solids (TDS)** - TDS is a measure of the dissolved substances in water such as calcium, magnesium, sodium, potassium, chloride, sulfate, bicarbonate, and nitrate. TDS removal is the primary objective of the RO process. Dissolved solids test results are reported in terms of milligrams per liter (mg/L).
- **Electrical Conductivity (EC)** - The electrical conductivity is a temperature dependent indication of the TDS of the water. EC is either expressed as milli-Siemens per centimeter or micro-Siemens per centimeter (mS/cm or  $\mu$ S/cm), and it can be used as an analogous measure of TDS. In this report, the values for EC are reported in both mS/cm and  $\mu$ S/cm. Values reported from the laboratory were taken at 25°C while all values taken in the field were temperature compensated.
- **Total Suspended Solids (TSS)** - TSS is a measure of the undissolved suspended substances in water. TSS can be a wide variety of suspended organic and inorganic materials. Suspended solids test results are reported in terms of milligrams per liter (mg/L).
  - **Turbidity** – Turbidity is an indirect measurement of the suspended solids present in water. It measures the amount of light scattered by the particles suspended in the water. The presence of turbidity in the feedwater to the RO system above 0.5 nephelometric turbidity units (NTU) indicates material in the water that may foul the RO membranes and is a performance goal measure for filtration processes.

- **Silt Density Index (SDI)** – SDI measures the level of materials in the water that will plug a 0.45  $\mu\text{m}^1$  filter. It is an indicator of the fouling potential a particular water source has on RO membranes. Typical RO membrane warranties require that SDI remain below 4.
- **pH** - pH is a term used to express the intensity of the acid or alkaline condition of a solution. The pH scale ranges from 0 to 14. Acidity increases as pH declines from 7 to 0. Alkalinity increases as pH increases from 7 to 14. Acceptable pH range in household water lies between 6.5 and 8.5.

After switching the source of the RO plant feedwater from the tile drain to the new wells, the quality of the RO feedwater changed. The well water quality was better than the tile drain water quality. The only exception was TSS, where water from the tile drain system contained less TSS than water from the wells. This did not impact RO permeate (desalted water) quality as the plant’s pretreatment filtration system produced water with acceptable SDI for both water sources.

**Table 3** presents average water quality for the years shown. Complete water quality data is presented in **Table 5** for the feed and product streams and in **Table 9** for the concentrate stream.

**Table 3. Comparisons of Source Water**

| <b>Feed Water<br/>(Irrigation Period)</b> | <b>Yr. 2000<br/>(Tile Drain)</b> | <b>Yr. 2002<br/>(Wells)</b> |
|---|----------------------------------|-----------------------------|
| TDS (mg/L)                                | 7,010                            | 3,980                       |
| Feed EC (mS/cm)                           | 10.2                             | 6.2                         |
| TSS (mg/L)                                | 4.0                              | 4.4                         |
| Turbidity (NTU)                           | 12.4                             | 17.4                        |
| SDI (after filtration)                    | 2.77                             | 1.94                        |
| Feed pH                                   | 7.3                              | 7.1                         |

<sup>1</sup>  $\mu\text{m}$  = micron = one millionth of a meter = 0.00004 inches.

---

## Shallow Water Characteristics

The quality of the shallow water collected by the tile drain system varied throughout the 2000 irrigation season. As shown in **Figure 5**, the SDI and conductivity (EC) values were influenced by application of irrigation water. Note that all SDI values were taken after filtration.

During the irrigation periods, the EC values decline and the SDI values of the filtrate increase. This happens because fresh water flows into the zone from which the tile drain system collects water diluting the salty water. Dilution causes a decrease in the conductivity of the feed water.

Furthermore, as the fresh water percolates through the soil, it carries suspended solids into the tile drain system. The addition of these suspended solids causes the SDI of the filtrate during irrigation periods to increase.

The tile drain may be generally characterized as moderately saline with low turbidity. Data taken during the year 2000 showed that the average turbidity of the tile drain water was 12. Filtration ahead of the RO equipment was required because RO requires feedwater turbidity of less than 1 NTU.

**Appendix A, 2000 Demonstration Plant Data**, contains information on the demonstration plant using tile drain water to supply the demonstration plant feedwater.

Figure 5: Filtrate SDI and EC History for 2000 (Tile Drain)

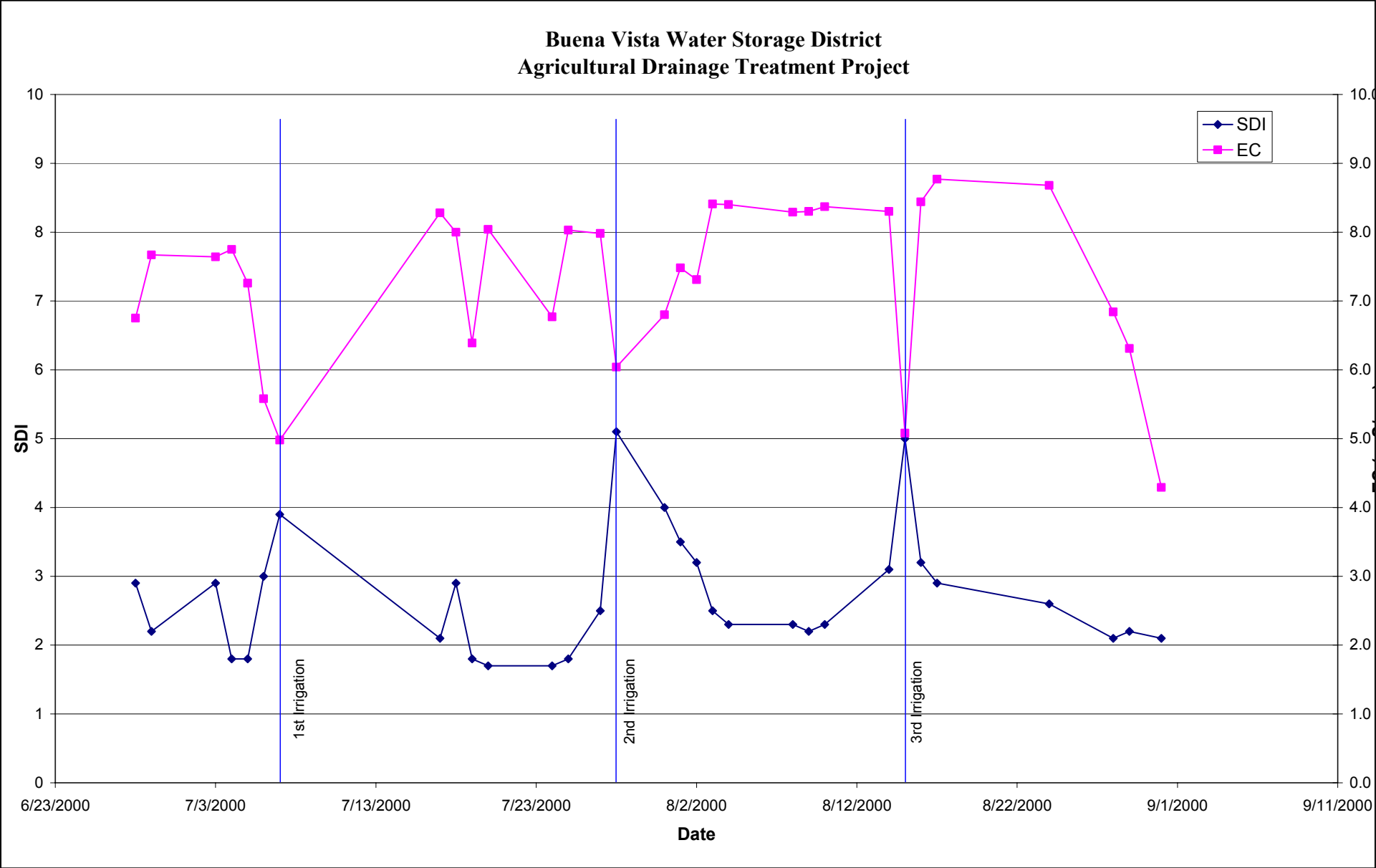
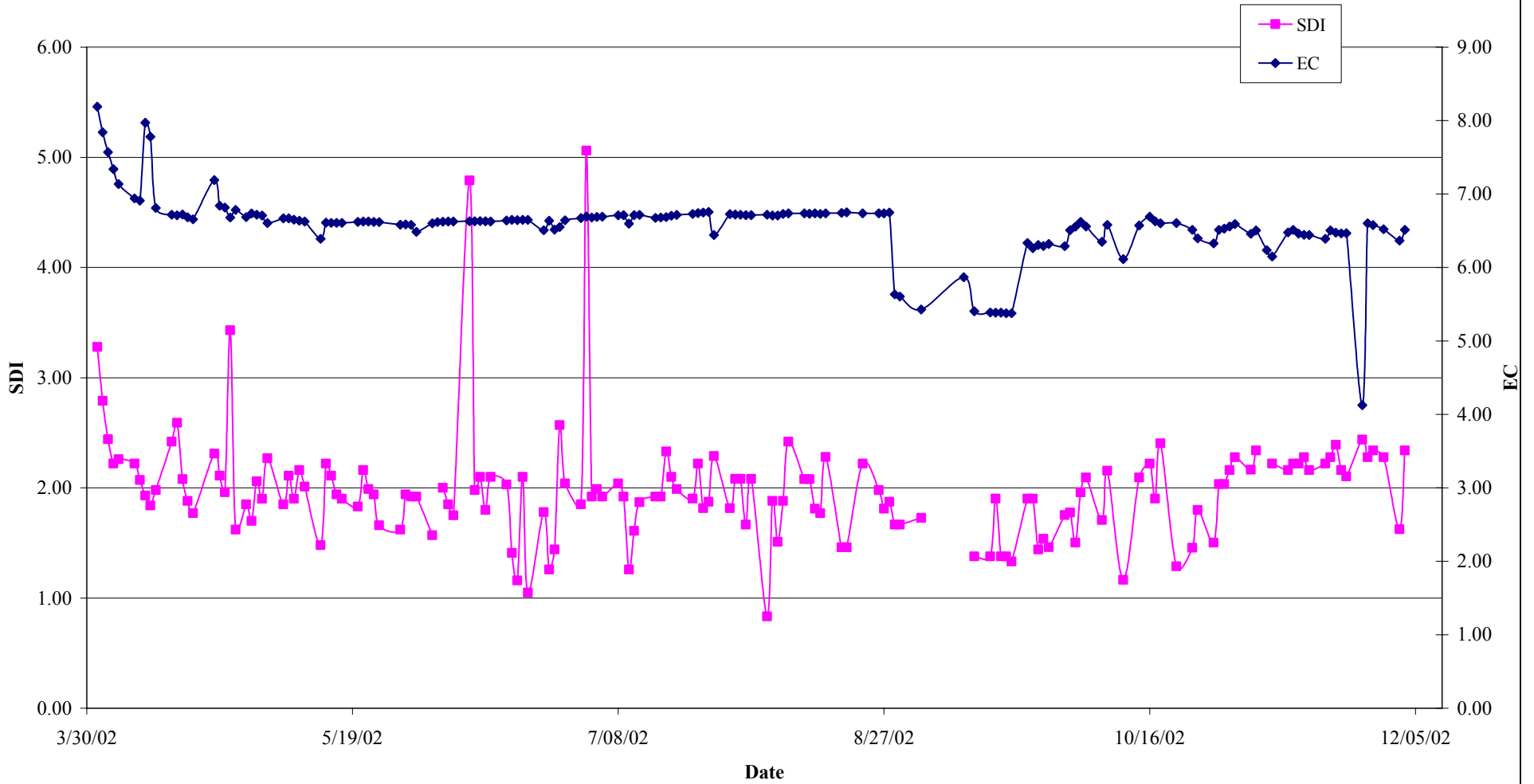

Figure 6: Filtrate SDI and EC History for 2002 (Well Water)

### Buena Vista Water Storage District Agricultural Drainwater Treatment Project





---

## Well Water Characteristics

The water supplied to the RO demonstration plant during 2002 came from the two wells drilled during the winter of 2001. As shown in **Table 3**, the well water had lower TDS than the tile drain water.

Because the North and South Wells pump from deeper within the saline aquifer, there is less impact resulting from irrigation on EC and filtered water SDI as compared to the tile drain water (see **Figure 6**). Whereas the EC of the tile drain water varied from about 4.3 mS/cm to almost 9.0 mS/cm (see **Figure 5**), the EC of the well water was about 7.7 mS/cm during most of the time the demonstration plant was operated in 2002. And, whereas the SDI of the filtered tile drain water was widely variable (see **Figure 5**) and averaged about 2.8, the SDI of the filtered well water was reasonably consistent and averaged less than 2.0.

Water quality data for the well water is presented in **Appendix B**.

# Treatment Process

---

## Pretreatment Filtration System

The pretreatment filtration system was previously used in a DWR seawater-desalting project at William R. Hearst State Beach Park in San Simeon. The media filtration system consisted of four 36-inch diameter, 72-inch tall vertical fiberglass reinforced plastic (FRP) pressure vessels. An inlet baffle is provided inside the top opening of each vessel to deflect the water entering the tank. Slotted laterals are arranged around a central hub installed in the dished bottom of the vessel. The tops of the vessels are painted to decrease the effects of UV radiation. Each vessel weighs approximately 3,000 pounds when fully loaded with media.

Three of the four filters contain anthracite and garnet media and the fourth filter contains anthracite and sand media. The media for the garnet filters consists of:

- 14.5 inches (500 pounds) of anthracite coal (size 0.8 mm to 1.0 mm) on top;
- Of 12.5 inches (1100 pounds) of #50 mesh garnet;
- Supported by 3 inches (300 pounds) of #8 mesh garnet;
- On top of 11 inches (650 pounds) of pea gravel.

The anthracite/sand filter was arranged somewhat differently, with only three layers of media:

- 14.5 inches (500 pounds) of anthracite working media;
- On top of 15.5 inches (1400 pounds) of fine sand;
- Supported by 11 inches (650 pounds) of pea gravel.

Sketches of the filters are shown in **Figure 7, Garnet and Sand Filters**.

In order to obtain the desired RO feed water quality it was necessary to add coagulant (alum [aluminum sulfate]) to the filter feedwater. The addition of coagulant helped the suspended solids in the feed water to agglomerate, which makes them easier to filter out.

A chemical injection facility was provided to add coagulant to the feed water. Alum was chosen for the coagulant due to its widespread use and availability.

The alum was held in a 55-gallon drum prior to injection and fed into the influent water by a solenoid-operated chemical injection pump at a rate of 0.18 gallons per day (gpd). This provided an alum concentration of 4 mg/L in the influent water.

The four filters were operated in two separate trains consisting of two filters each. Each train was capable of supplying the necessary feed water flow to the RO plant. At 20 gpm (design feed water flow to the RO) filter surface loading was 2.8 gpm/ft<sup>2</sup>. With both filter trains running, filter loading would have been 1.4 gpm/ft<sup>2</sup>. However, the system was never operated with both trains running.

Filter Train #1 consisted of two garnet filters connected in series, while Filter Train #2 consisted of one garnet filter followed by a sand filter connected in series.

The filters were installed in a manner to allow backwashing of either of the two filter trains without taking the other train offline. RO permeate was used to backwash the filters. The backwash water was stored in a 2250-gallon tank. The backwash flow rate was approximately 60 gpm.

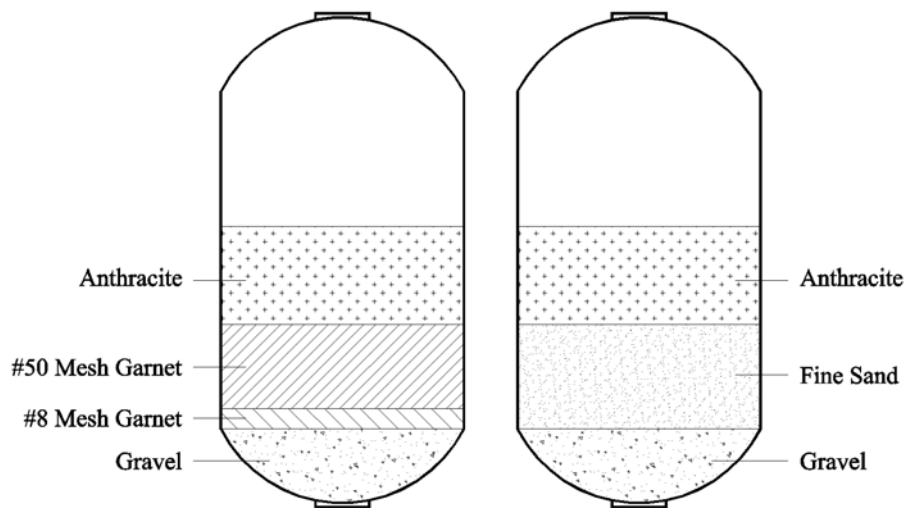

**Figure 7: Garnet and Sand Filters**

---

## Reverse Osmosis System

The RO treatment system was trailer mounted and had a nominal permeate capacity of 16 gpm. It was equipped with a cartridge filter, boost and high-pressure pumps, monitoring instrumentation, and an automatic control system. The automatic control was connected to a computer that logged RO performance data. A flow diagram describing the demonstration unit is provided in **Figure 8**.

RO membranes were enclosed in six, three-element, four-inch diameter pressure vessels, arranged in a 2:2:1:1 array. **Table 4** lists the membranes used in the pilot.

**Table 4. RO Membranes & Manufacturers**

| Membrane Type          | Manufacture | Stage  | Date Installed |
|------------------------|-------------|--------|----------------|
| TFC High Rejection     | KOCH        | First  | 8/15/00        |
| TFC Ultra Low Pressure | KOCH        | Second | 8/30/00        |

The RO feed water was treated with muriatic acid (HCl) and scale inhibitor prior to entering the membranes. Target feed water pH and target scale inhibitor injection rates were 6.7 and 4.6 mg/L, respectively. In order to meet these injection rates using the chemical injection pumps, it was necessary to dilute the chemicals with RO permeate.

An initial projection of RO performance was made using water analyses sampled from nearby Well 38. The RO projection is provided in **Appendix C**. A mineral analysis of the water sampled from Well 38 is provided in **Table A.1** of **Appendix A** (under 1/6/00).

---

## Daily Operator Tasks

The operators performed daily tasks as follows:

- Recorded and entered operating data into a computer spreadsheet. This data included the following: stream

flowrates, system and stream pressures, temperatures, turbidities, the SDI, and the RO feed.

- Checked filter pressure drop and backwashed the filter when necessary.
- Adjusted the RO permeate to correct the flowrate.
- Checked the cartridge filter pressure drop. Replaced the cartridges when necessary.
- Checked the chemical tank levels and replenished as required.
- Checked the chemical feed rates by calculating the amount pumped from the tanks. Adjusted if necessary.
- Checked the mechanical equipment. Called for service if required.

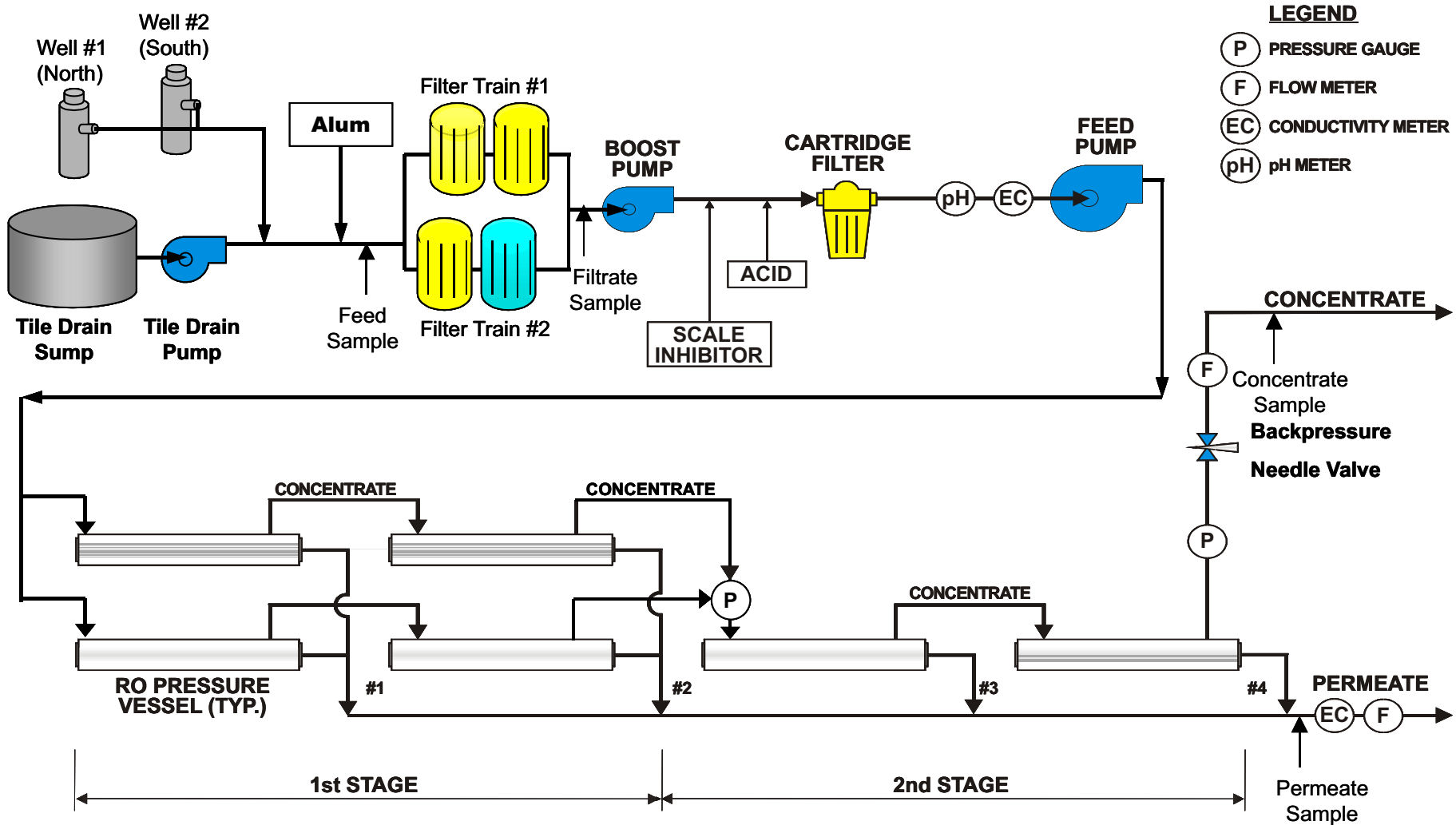

- LEGEND**
- (P) PRESSURE GAUGE
  - (F) FLOW METER
  - (EC) CONDUCTIVITY METER
  - (pH) pH METER

#1, #2, #3, and #4 are permeate sample points.



**BOYLE Engineering Corporation**

BUENA VISTA WATER STORAGE DISTRICT

**FIGURE 8**

DEMONSTRATION PLANT FLOW DIAGRAM

*BOYLE ENGINEERING CORPORATION*

# RO Plant Performance Evaluation

---

## Filter Performance Data

Throughout the 2000 and 2002 irrigation seasons, both filter trains were used interchangeably but not at the same time. During the year 2002 irrigation season, Filter Train #2 was used more often than Filter Train #1, however the two trains produced similar results.

Operating logs containing filter performance data are presented in **Table D.1** and **Figures D.2** and **D.3** of **Appendix D**.

---

## RO Performance Data

Initially, the RO demonstration plant was designed to recover 70% of the feed water, while removing as much as 95% of the total dissolved solids. Because the quality of the feed water from the North and South Wells was better than that from the tile drain system, the recovery was increased to 75%. TDS removal averaged 97% throughout the life of the project. Tabulated performance data for the RO system can be found in **Appendix E**.

### Normalized Flux Variations:

There are two primary standards of performance for RO systems: flux and salt rejection. Temperature and the salinity of the feed water affect flux and salt rejection. It is necessary to normalize the data to standard conditions in order to obtain a realistic evaluation of the performance of the system.

Flux is a measure of the amount of permeate (desalted water) produced per square foot of membrane surface per unit of time. It is typically reported in gallons per day per square foot of membrane area (gfd). When comparing different membranes, specific flux is typically reported<sup>2</sup>. This is the flux produced by 1 psi of net driving pressure. Specific flux typically increases by about 3 percent per degree Celsius. This is because as the temperature of the water increases, its viscosity decreases. Normalized permeate flux is reported as specific flux at 25 degrees C.

---

<sup>2</sup> A simplified definition of *net driving pressure* is the pressure available to drive water (permeate) through the RO membrane.

Salt rejection describes the amount of salt that the membranes prevent from passing into the permeate. Salt rejection is impacted by temperature, but to a lesser degree than flux.

Normalized flux and salt rejection were monitored throughout the operation of the demonstration plant to determine the condition of the RO membranes. As the membranes fouled, normalized flux dropped. A drop of about 15 percent indicated the need to clean the membranes.

**Figure 9** presents the normalized flux and net driving pressure for the RO system for 2002. Ten days after 2002 startup, the demonstration plant experienced a drastic drop in normalized flux from greater than 0.10 gfd/psi to about 0.08 gfd/psi. Inspection revealed a green algae-like substance in a rotometer (flow measuring device). Bio fouling was suspected, and the membranes were cleaned using detergent and citric acid.

Shortly after startup, a well water quality analysis was received. The report indicated a better feed water quality than observed in 2000 when the feedwater for the plant was taken from the tile drain system. Subsequently, the RO recovery rate was increased from the 50% achieved in 2000 to 70%.

On day 30, the second new well was brought online. It appeared that that well initially produced a significant amount of sediment. Some of the materials got through the filters and entered the RO membranes, reducing the normalized flux. The membranes were chemically cleaned<sup>3</sup> on day 37, and the flux recovered.

On day 56, the pH/temperature analyzer probe was replaced. Prior to the replacement, the operator was reporting temperatures from the conductivity/temperature probe. Afterward, the operator reported temperature from the pH/temperature probe.

Based on field observations, the pH/temperature probe read in a range of 1.0 to 1.5 degrees Celsius higher than the conductivity/temperature probe. This led to an adjustment of the normalized flux value, reducing it to approximately 0.080 gfd/psi.

---

<sup>3</sup> Chemical cleaning consisted of a detergent cleaning and a low pH cleaning. The former includes cleaning with soap (in this case, Tide laundry detergent) to get rid of the organics, while the latter includes adding citric acid to get rid of the mineral scales.



On day 111, the recovery was increased from 70% to 75%. The normalized flux had slightly decreased by this point, but then remained steady at 0.077 gfd/psi. On day 124, due to a decreasing normalized flux, the membranes were chemically cleaned. The cleaning had no effect on normalized flux. However, the recovery rate remained at 75% (producing 15 gpm permeate).

On day 152, a sizeable RO pressure drop was noticed as both the flowrates and the recovery sharply declined. At this point, the normalized flux had dropped to below 0.070 gfd/psi. Initial thinking was that the feed pump had a mechanical failure, however, further probing proved that the pressure relief valve had failed to seat properly. The valve failure was causing the plant to recycle concentrate.

Figure 9: Normalized Flux 2002

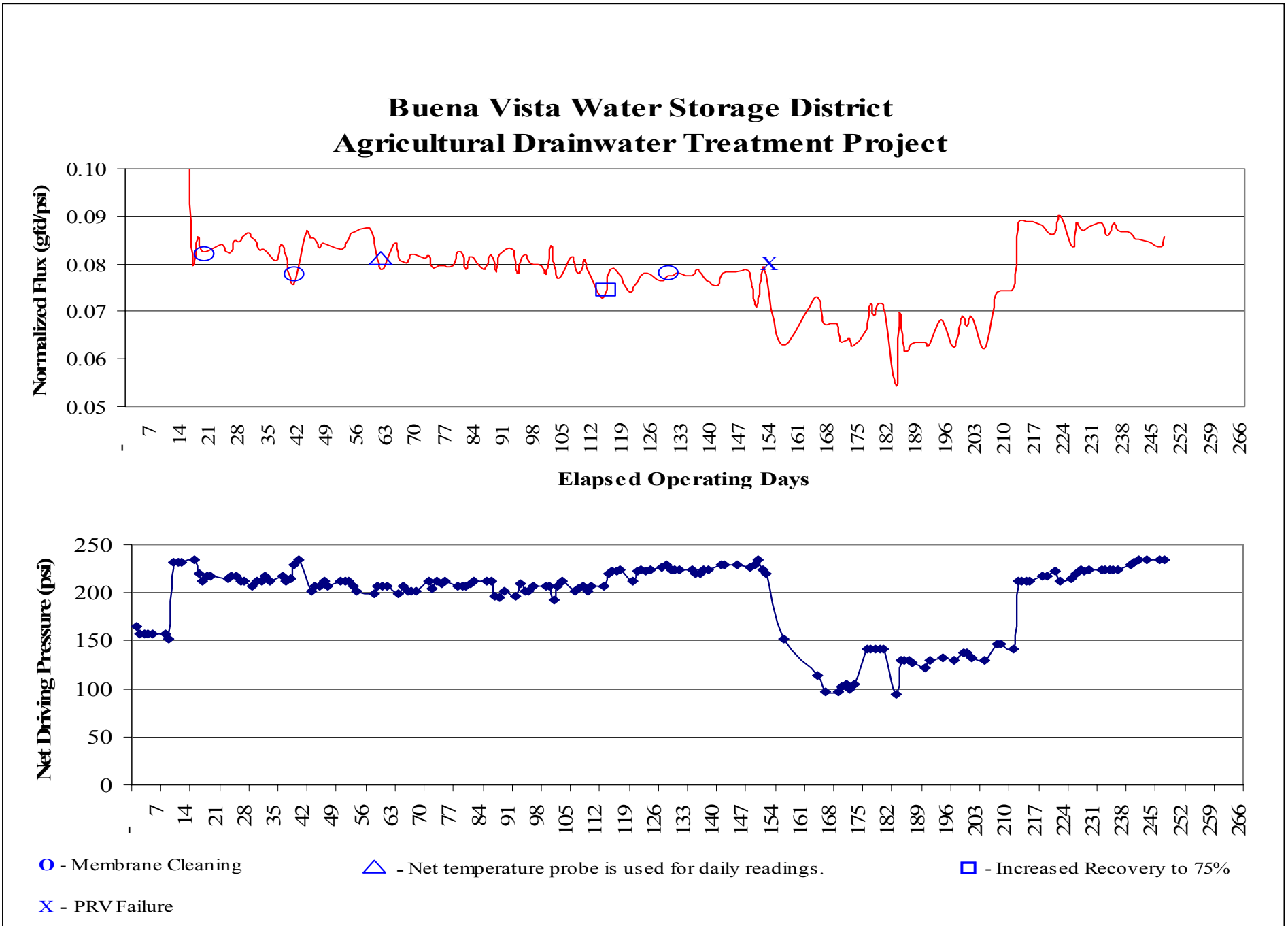

On day 208, the pressure relief valve was replaced and the RO pressures as well as the flowrates and recovery rate returned to levels seen before the pressure drop. The normalized flux increased to an average of 0.087 gfd/psi and remained near this level through the end of the project.

**Figures 10** through **14** present additional operating data for the plant.

Figure 10: Demonstration Plant Flowrates 2002

Buena Vista Water Storage District  
Agricultural Drainwater Treatment Project

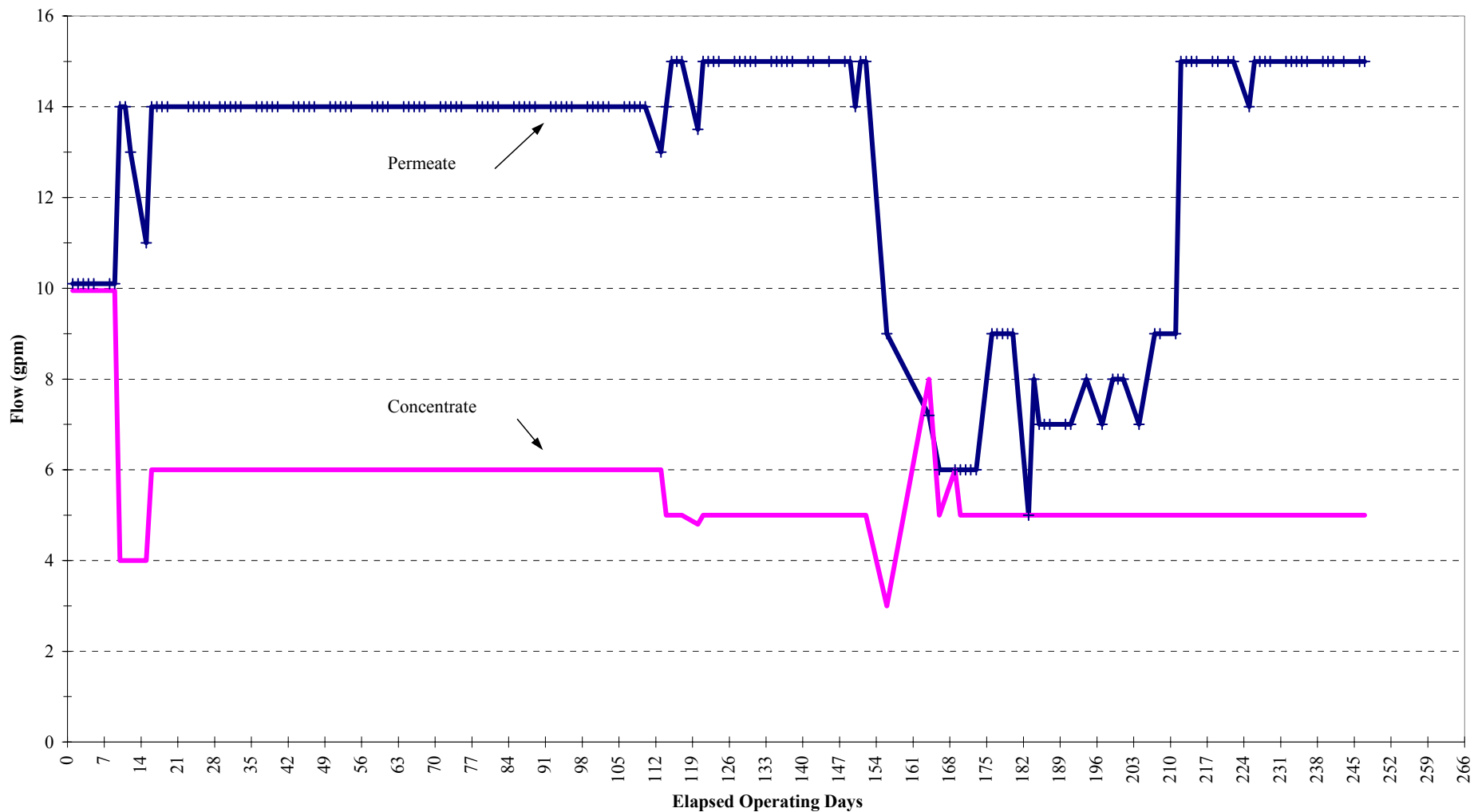

Figure 11: Demonstration Plant Pressures 2002

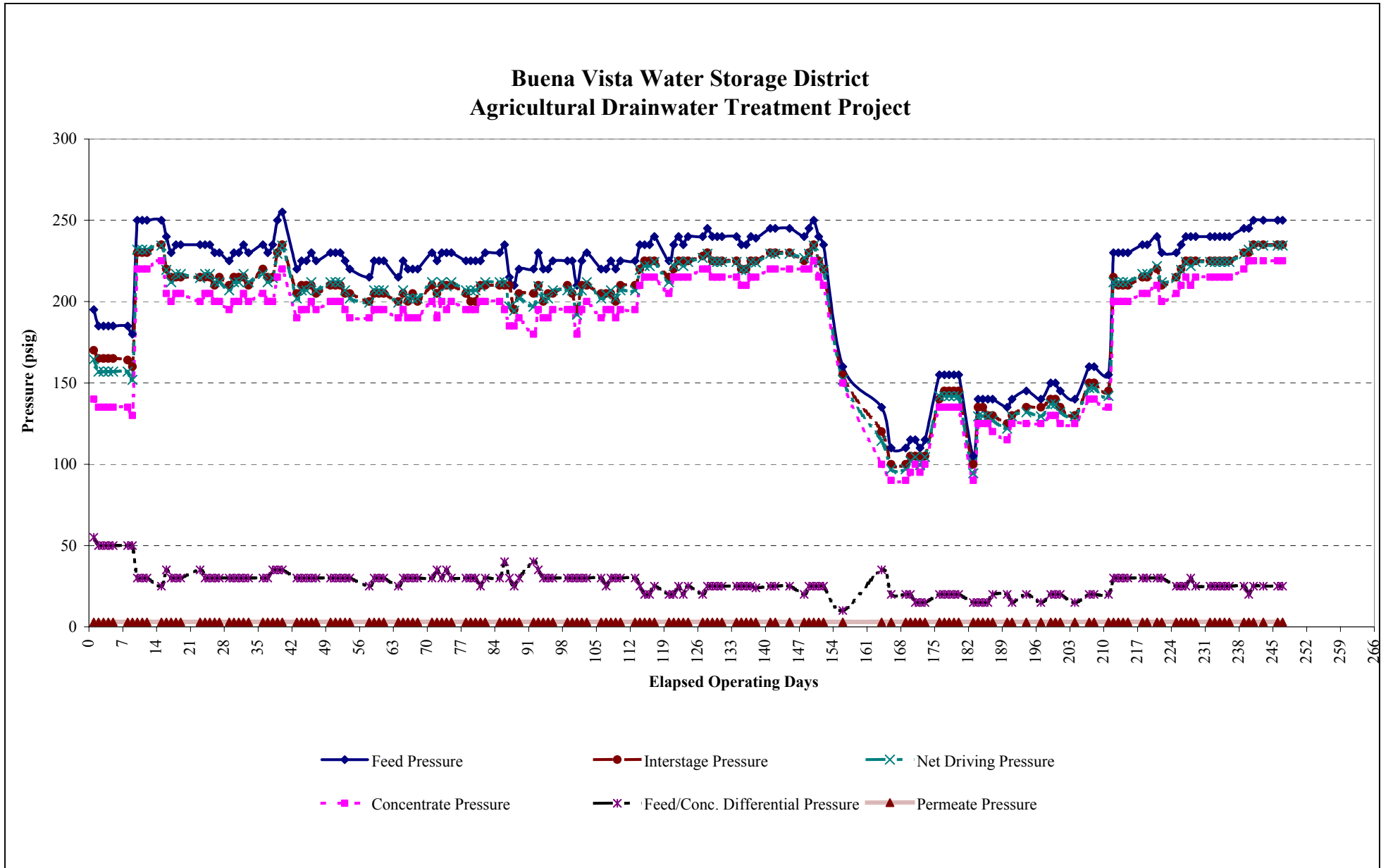

Figure 12: Electrical Conductivities 2002

Buena Vista Water Storage District  
Agricultural Drainwater Treatment Project

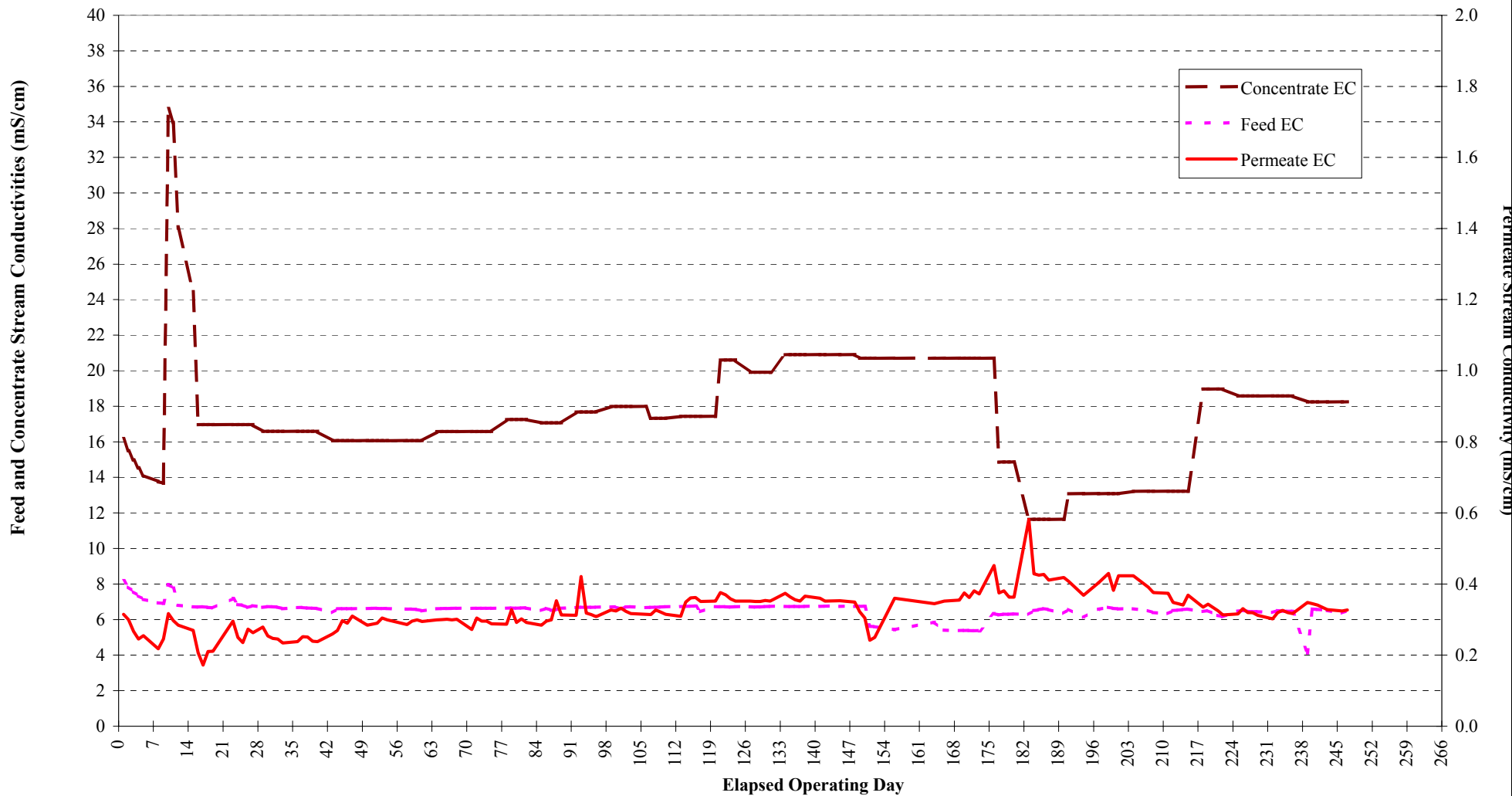

Figure 13: Permeate Electrical Conductivities 2002

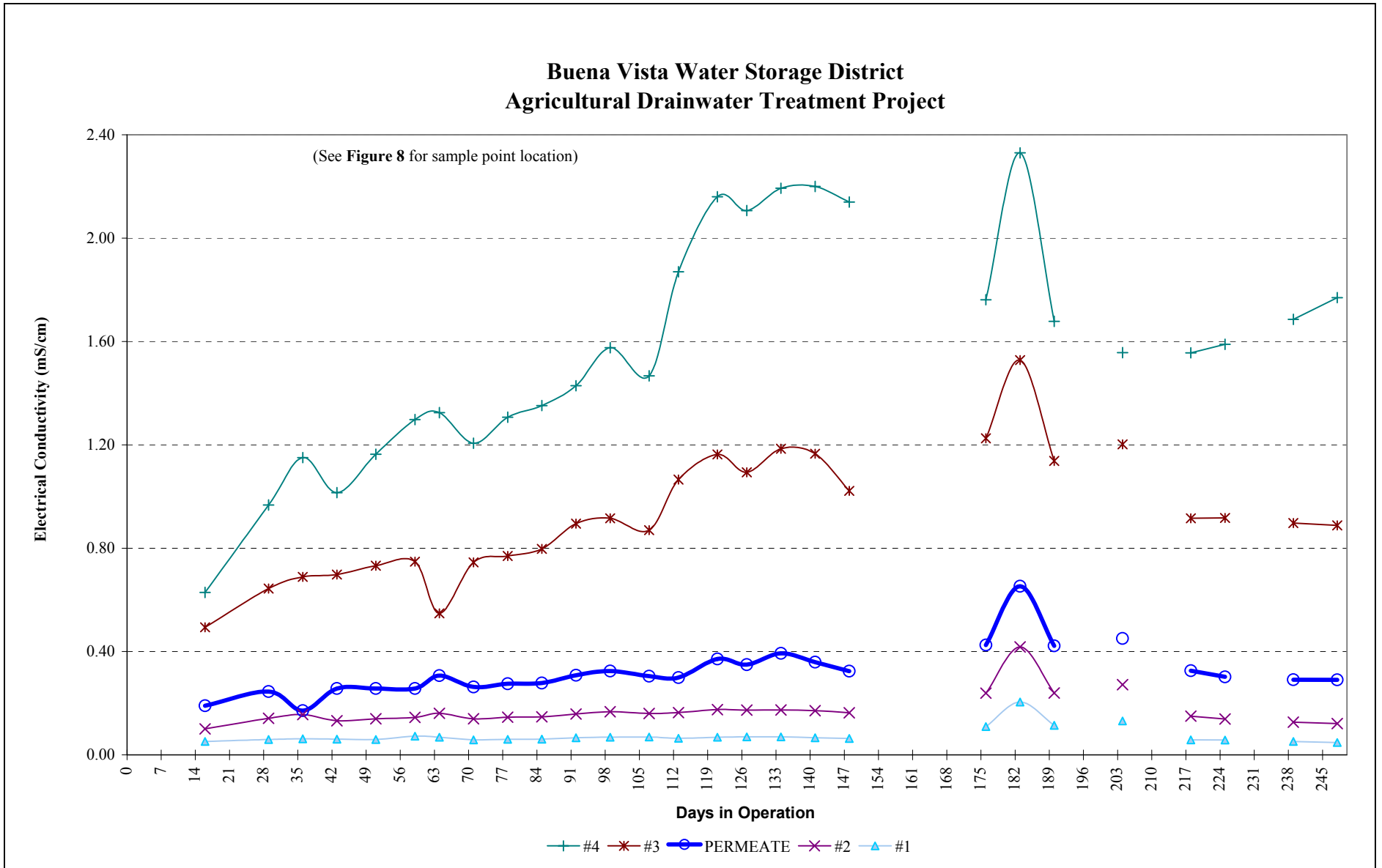
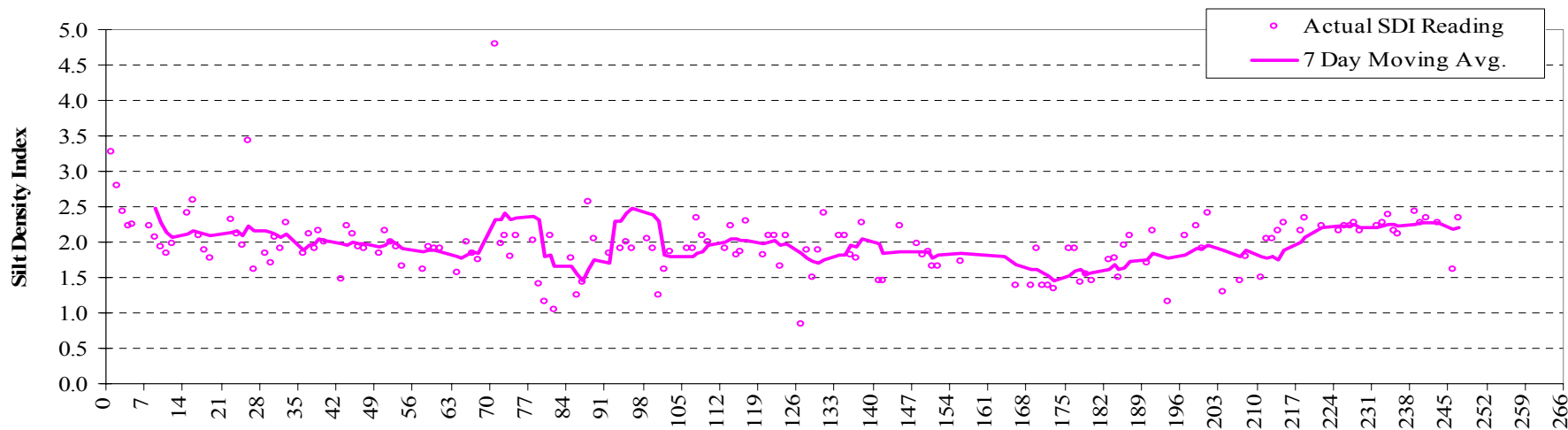
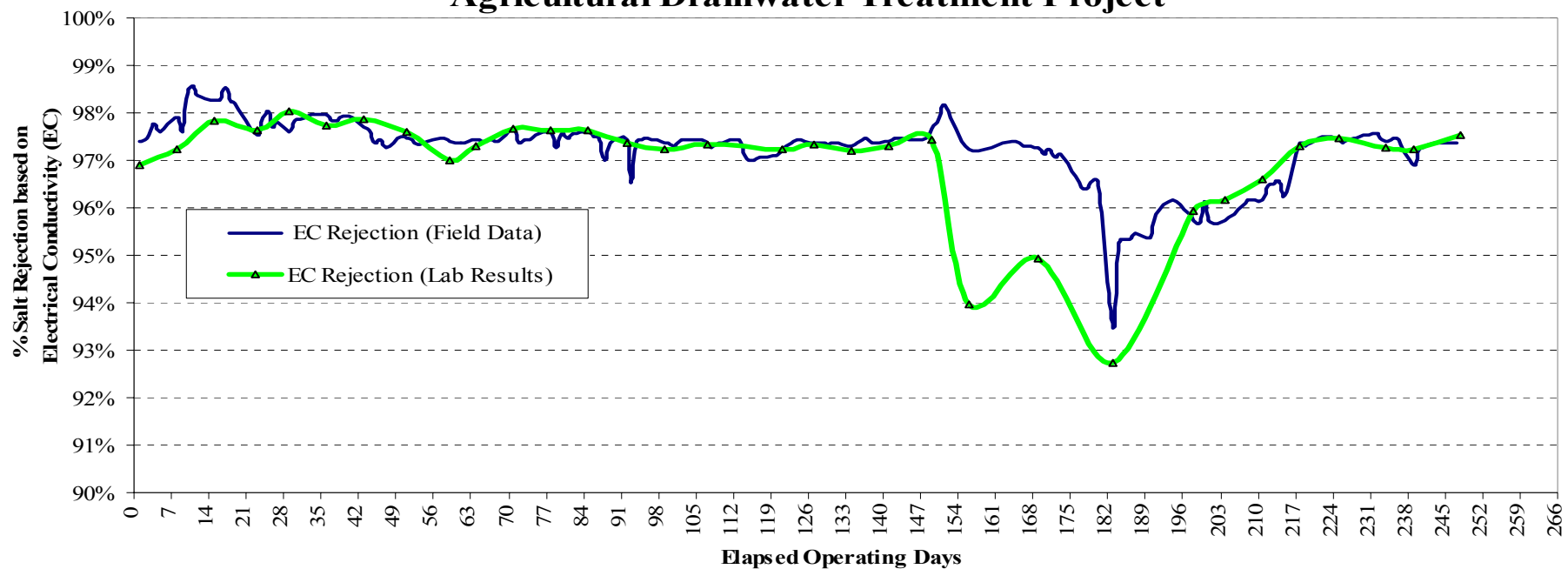

Figure 14: Demonstration Plant Salt Rejection 2002

### Buena Vista Water Storage District Agricultural Drainwater Treatment Project





---

## Laboratory Water Quality Analysis

**Figure 16** shows the TDS (salt) rejection rate consistently stayed between 97%-98%. In **Figure 16**, the rejection rates are differentiated by ionic species. As expected the RO membranes are more effective at rejecting divalent<sup>4</sup> ions such as calcium (2+), magnesium (2+), and sulfate (2-), versus the monovalent ions such as sodium (1+), chloride (1-), and bicarbonate (1-). The majority of the ions varied slightly in terms of their rejection; rejection rates were not dependent upon which filter train was used.

### Evaluating RO Membrane Salt Rejection

Besides using operating data to formulate values such as normalized flux and process stream conductivities or driving pressures to characterize the health of the RO membranes, analytical lab data can also be used to measure the effectiveness of the RO membranes. The analytical recovery and rejection rates of TDS from the process streams were used in this study.

The TDS rejection rate is defined as the ratio of the permeate TDS concentration divided by the average of the filtrate and concentrate TDS concentrations. Likewise, rejection rate for each ionic species is also defined as the ratio of the permeate ionic species' concentration divided by the average of the filtrate and concentrate ionic species' concentrations. These are typically expressed as *percent rejection*.

TDS Analytical Recovery is a mass balance calculation. It is defined as the ratio of the mass (pounds) of material that exits the membranes over the mass of material that enters the membranes. In this case, it is the sum of the mass of the TDS found in the permeate and the

---

<sup>4</sup> TDS results from the dissolving of minerals such as calcium sulfate (gypsum) and salt (sodium chloride). When the minerals dissolve, they separate into the *ions* that compose them. For example, calcium sulfate consists of calcium ions and sulfate ions. Sodium chloride consists of sodium ions and chloride ions. Ions are electrically charged either positively or negatively. Ions can have a single charge (monovalent) or multiple charges (multivalent). Divalent ions have twice the electrical charge of monovalent ions. Sodium and chloride are examples of monovalent ions. Calcium and sulfate are examples of divalent ions.

concentrate divided by the mass of the TDS found in the filtrate. A value significantly different than 100% indicates an error in measurement. Error sources include incorrect flow rate measurement, improper sampling technique, and analytical errors (See **Figure 15** for values relating to the TDS Analytical Recovery).

Figure 15: TDS Rejection 2002

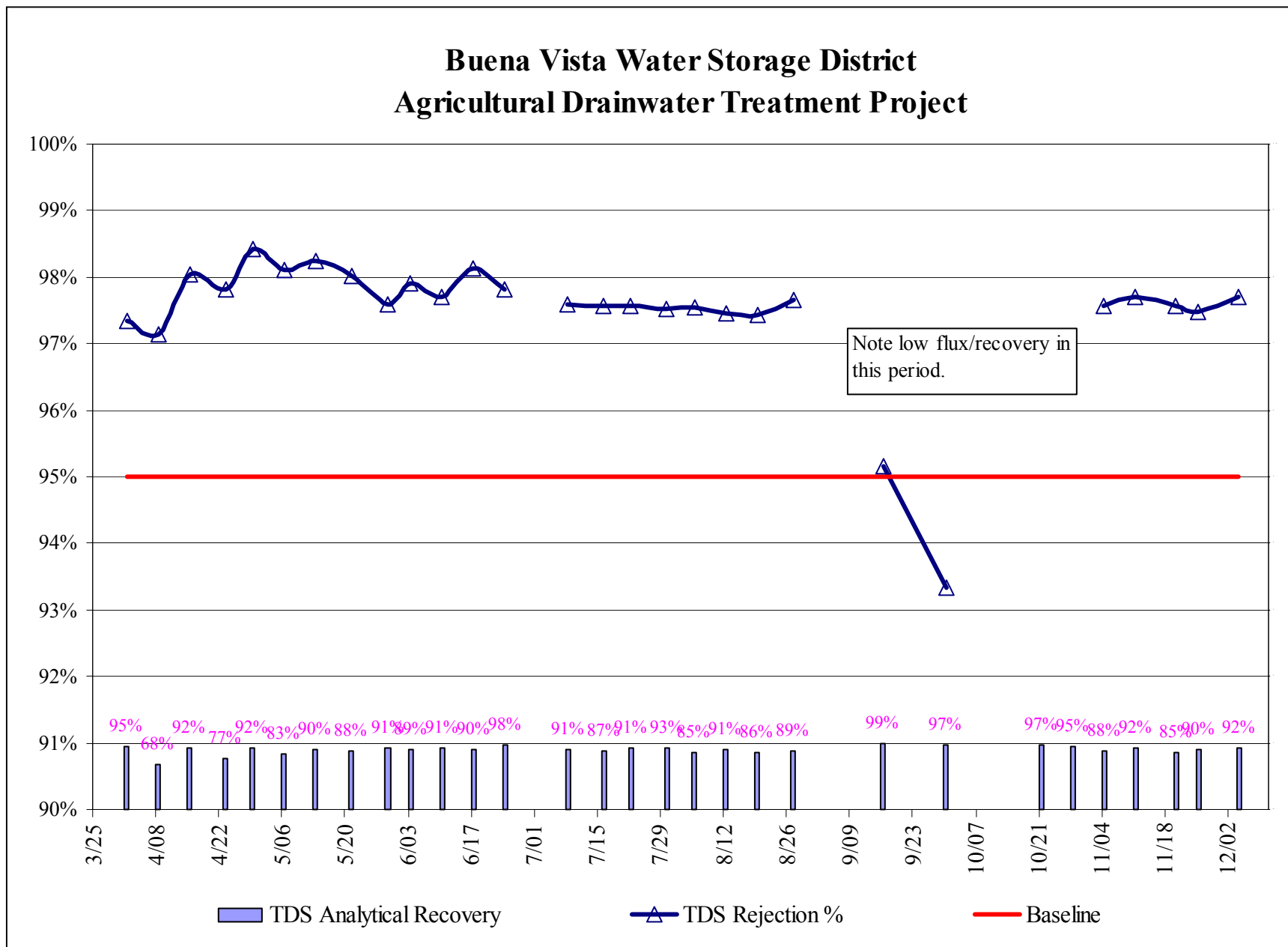
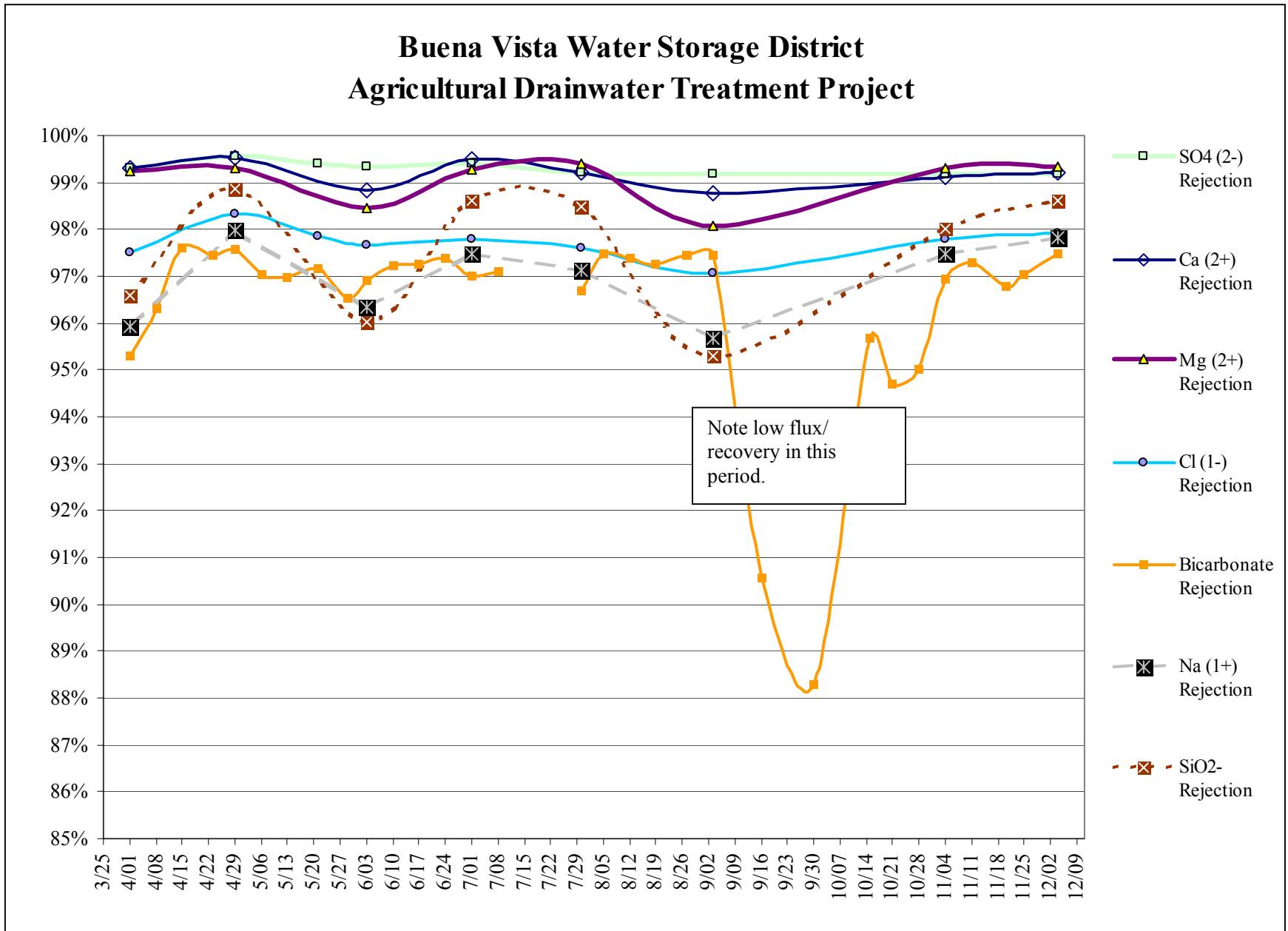

Figure 16: Ion Rejection 2002



## Total Organic Carbon Results

Total organic carbon (TOC)<sup>5</sup> concentration in the feed water varied throughout the testing period. The RO process typically provided over 80% rejection of organics.

Typical TOC concentration in the feed water ranged between 5.0 and 8.0 mg/L. During the start of the irrigation period on June 4<sup>th</sup>, 2002, a value of over 10.0 was observed, however, this high TOC concentration was not seen again. TOC in the feed water promotes bio fouling of the RO membranes. An increase in TOC will lead to more downtime, as the plant would have to be idled more often for membrane cleaning.

Alum coagulation was used as a supplement to the filter vessels. Injection began April 15<sup>th</sup>, 2002, two weeks after startup. By comparing the TOC values between the Feed and Filtrate Streams in **Figure 17**, it can be seen that filtration did not appreciably reduce TOC in the demonstration plant's feedwater.

---

<sup>5</sup> TOC is the sum of all forms of organic carbon found in the water. Organic carbons are combinations of carbon and hydrogen sometimes associated with other elements such as chlorine, oxygen, etc. Examples of substances that make up TOC include natural plant and animal materials, herbicides, fertilizers, insecticides, petroleum related substances, etc.

Figure 17: Total Organic Carbon Rejection 2002

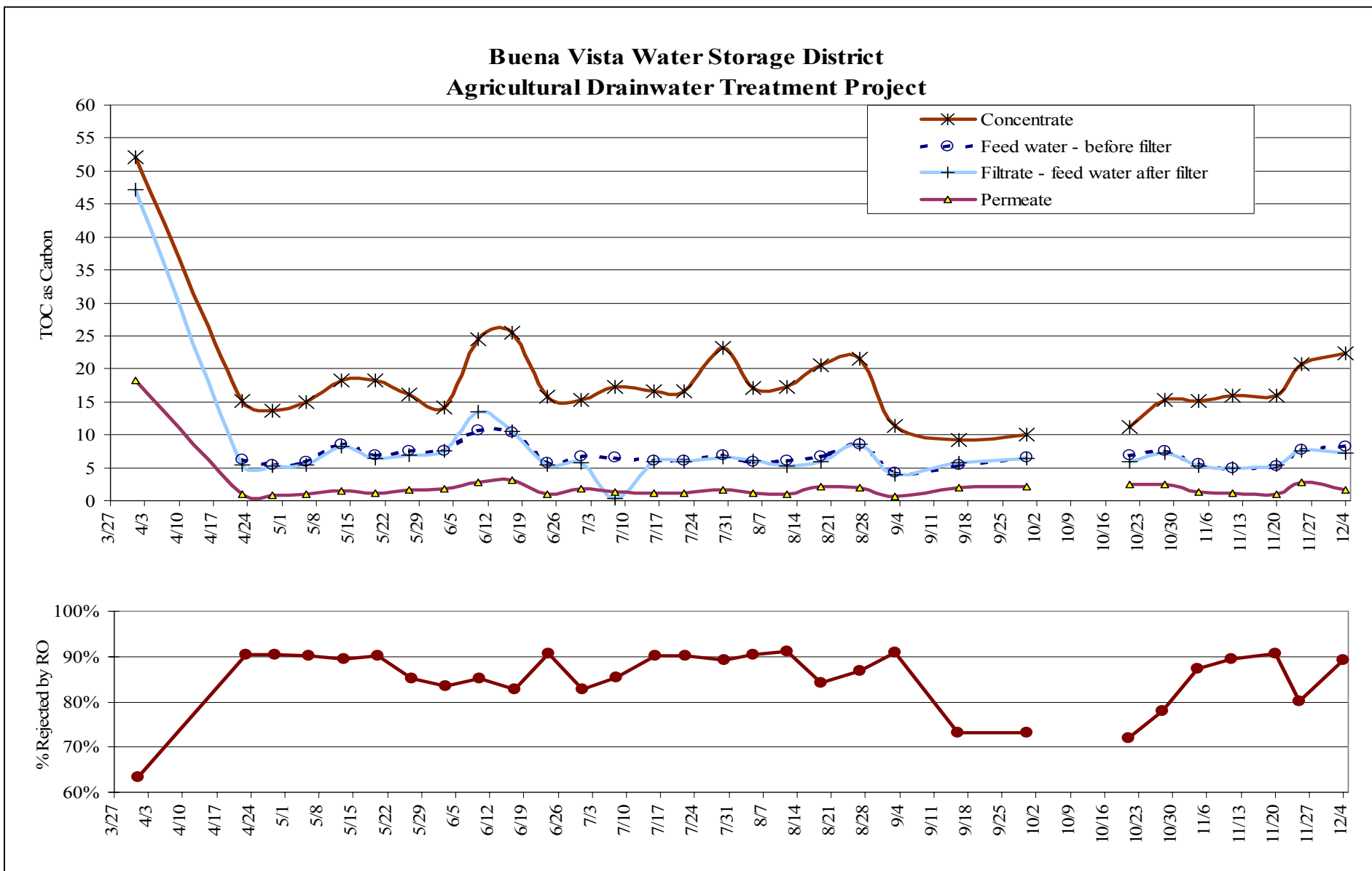

# Costs

Costs to construct a 1 MGD, 2 MGD, 5 MGD, and 10 MGD plant employing filtration and RO such as was demonstrated were estimated. The estimates are based on a 75% recovery rate and using the reclaimed water for irrigation. Because the TDS of the permeate exiting the RO system was less than 200 mg/L, the permeate could be blended with filtered raw water (bypass) to increase the final TDS concentration to 750 mg/L for irrigation supply (14% filtered but undesalted water/86% permeate or a ratio of 6.2:1 permeate to undesalted water).

**Table 5** shows the feed and product water qualities.

**Table 5. Feed and Product Water Qualities**

| <b>Constituent</b> | <b>Bypass<br/>(mg/L)</b> | <b>Permeate<br/>(mg/L)</b> | <b>Blended<br/>Product<br/>(mg/L)</b> |
|--------------------|--------------------------|----------------------------|---------------------------------------|
| Calcium            | 344                      | 6                          | 60                                    |
| Magnesium          | 62                       | 1                          | 11                                    |
| Sodium             | 950                      | 49                         | 193                                   |
| Barium             | 0.45                     | 0.01                       | 0.09                                  |
| Strontium          | 2.96                     | 0.05                       | 0.5                                   |
| Iron               | 2.34                     | 0.04                       | 0.4                                   |
| Bicarbonate        | 264                      | 18                         | 57                                    |
| Chloride           | 1455                     | 68                         | 290                                   |
| Sulfate            | 873                      | 14                         | 151                                   |
| Silica             | 28                       | 1                          | 5                                     |
| pH                 | 7.20                     | 5.71                       | 6.26                                  |
| TDS                | 3,848                    | 154                        | 752                                   |

Estimates of capital and operating and maintenance costs for various production rates are presented in the following tables. Costs per acre of land drained are included in the cost tables. These costs were developed assuming that each acre of farmland produces 0.5 AF of drain water per year. The number of acres that could be served by each plant size is obtained by multiplying the feed AFY by two and assuming a Plant Usage Factor (PUF) of 95%. Plant Usage Factor is the hours per year that a plant is operated divided by the total number of hours in a year (8760 hours).

### **Capital Cost Basis**

RO System - \$1.00/gpd product

Electrical Cost – 10% of the total Equipment Cost

Building Cost - \$70/sqft

Storage Tanks - \$0.50/gallon capacity

Engineering & Contingencies – 60%

Conceptual layout designs are shown in **Appendix F**.

### **Operating and Maintenance Cost Basis**

Membrane replacement cost was calculated using a membrane life of 5 years.

Electrical power cost was assumed to be \$0.13/KW hr. The majority of the power cost is comprised of pumping power for the RO system, with 25% added for miscellaneous loads. Feed pressure is assumed to be 220 psig, as was seen in the demonstration plant.

Chemical costs are based upon consumption seen in the demonstration plant.

Maintenance cost is estimated to be 2 percent of the plant construction cost excluding engineering, administration, and contingencies.



### **Cost Per Acre Served**

Since a desalination plant treating agricultural drainage water must support itself both by producing saleable water and by increasing crop yields, it is important to know both the cost of water produced, and the cost per acre of land out of production. These costs are provided in **Tables 6** and **7**.

**Table 6** presents the capital cost both as a Grand Total and as a Capital Cost per Acre for each plant size and use. The cost per acre is calculated by dividing the total capital cost by the number of acres served by the plant. The number of acres served depends upon the feed flow to the plant and the amount of drainage water from each acre, which was assumed to be 0.5 acre-feet per year per acre. The feed flow varies for each plant size and use, depending upon the blending rate and the recovery in the RO system. Due to economies of scale, the capital cost per acre reduces from a little over \$1,000 per acre to about \$875/acre as plant size increases from 1 to 10 MGD.

**Table 7** presents the O&M cost both on a total annual cost basis and on an annual per-acre basis. The per-acre O&M cost is calculated by dividing the total annual O&M cost by the acres served, as provided in **Table 6**. As with capital costs, O&M costs show the economies of scale as costs decrease from about \$177/acre to \$126/acre as plant size increases from 1 to 10 MGD.

The costs presented in **Tables 6** and **7** do not take into account the cost of gathering or delivering the water, sale of produced water or offset water rights, or concentrate disposal.

**Water Cost Table 8** gives the cost of water in \$/AF assuming:

- Capital costs (**Table 6**) are amortized over 30 years at 8% interest;
- O&M costs are as shown in **Table 7**; and,
- Annual plant product water production (blend of permeate and undesalted water) is as shown in the table.

As shown in **Table 8**, the cost of water is estimated to range from \$459/AF (10 MGD plant) to \$651/AF (1 MGD). It should be noted, however, that these costs do not include the cost of collecting and transporting the saline water to the desalter or the costs of disposing of

the concentrate. However, the volume of saline drainage water would be reduced by 75%--that portion of the drainage water recovered as usable irrigation water. RO desalination costs would be reduced by the market value of the recovered usable water.

**Table 6. Capital Costs for 1, 2, 5, and 10 MGD Plant**

|                                     |     | <b>1 MGD</b>       | <b>2 MGD</b>       | <b>5 MGD</b>        | <b>10 MGD</b>       |
|-------------------------------------|-----|--------------------|--------------------|---------------------|---------------------|
|                                     |     | Irrigation         |                    |                     |                     |
| Feed (gpm)                          |     | 893                | 1788               | 4469                | 8940                |
| Bypass (gpm)                        |     | 96                 | 193                | 481                 | 964                 |
| RO Feed (gpm)                       |     | 806                | 1579               | 3935                | 7882                |
| Recovery                            |     | 75%                | 75%                | 75%                 | 75%                 |
| Product (gpm)                       |     | <b>694</b>         | <b>1389</b>        | <b>3472</b>         | <b>6946</b>         |
| Acres Served                        |     | 2,438              | 4,882              | 12,201              | 24,410              |
| RO Process Equipment & Installation |     | \$1,000,000        | \$2,000,000        | \$5,000,000         | \$10,000,000        |
| Filtration System                   |     | \$90,000           | \$100,000          | \$150,000           | \$300,000           |
| Electrical                          |     | \$200,000          | \$300,000          | \$640,000           | \$1,300,000         |
| Plant Control System                |     | \$200,000          | \$250,000          | \$290,000           | \$500,000           |
| Chemical Systems                    |     | \$150,000          | \$200,000          | \$200,000           | \$600,000           |
| Building Cost                       |     | \$175,000          | \$230,000          | \$300,000           | \$600,000           |
| Site Civil                          |     | \$10,000           | \$20,000           | \$20,000            | \$30,000            |
| <b>SUBTOTAL</b>                     |     | <b>\$1,825,000</b> | <b>\$3,100,000</b> | <b>\$6,600,000</b>  | <b>\$13,330,000</b> |
| Engineering & Administrative Fees   | 60% | \$1,100,000        | \$1,900,000        | \$4,000,000         | \$8,000,000         |
| <b>GRAND TOTAL*</b>                 |     | <b>\$2,925,000</b> | <b>\$5,000,000</b> | <b>\$10,600,000</b> | <b>\$21,330,000</b> |
| Capital Cost per Acre (\$/acre)**   |     | \$1,200            | \$1,024            | \$869               | \$874               |

\*Does not include concentrate disposal or cost to get product water to river.

\*\*Based on 0.5 Ac ft per Acre of drain water.

**Table 7. Annual O&M Costs for 1, 2, 5, and 10 MGD Plant**

|                               | <b>1 MGD</b>      | <b>2 MGD</b>     | <b>5 MGD</b>       | <b>10 MGD</b>      |
|-------------------------------|-------------------|------------------|--------------------|--------------------|
|                               | <b>Irrigation</b> |                  |                    |                    |
| Membrane Replacement Costs/Yr | \$22,000          | \$41,000         | \$99,000           | \$200,000          |
| Elec. Cost/Yr                 | \$170,000         | \$330,000        | \$830,000          | \$1,700,000        |
| Labor/Yr                      | \$150,000         | \$150,000        | \$300,000          | \$450,000          |
| CIP Chem Cost/Yr              | \$6,000           | \$12,000         | \$12,000           | \$24,000           |
| Chemical Cost/Yr              | \$28,000          | \$55,000         | \$140,000          | \$280,000          |
| Maintenance Cost/Yr           | \$56,000          | \$66,000         | \$210,000          | \$414,000          |
| <b>Total (\$/Yr)</b>          | <b>\$432,000</b>  | <b>\$654,000</b> | <b>\$1,591,000</b> | <b>\$3,068,000</b> |
|                               |                   |                  |                    |                    |
|                               |                   |                  |                    |                    |
| <b>\$/Ac-Ft</b>               | <b>\$400</b>      | <b>\$302</b>     | <b>\$294</b>       | <b>\$284</b>       |
| <b>\$/Kgal</b>                | <b>\$1.18</b>     | <b>\$0.90</b>    | <b>\$0.87</b>      | <b>\$0.84</b>      |
| <b>\$/acre</b>                | <b>\$177</b>      | <b>\$134</b>     | <b>\$130</b>       | <b>\$126</b>       |

**Table 8. Water Costs**

|                                | <b>1 MGD</b>      | <b>2 MGD</b> | <b>5 MGD</b> | <b>10 MGD</b> |
|--------------------------------|-------------------|--------------|--------------|---------------|
|                                | <b>Irrigation</b> |              |              |               |
| RO Permeate (AFY)              | 964               | 1,930        | 4,825        | 9,649         |
| Bypass (AFY)                   | 116               | 233          | 582          | 1,166         |
| Product Water (AFY)            | 1,080             | 2,163        | 5,406        | 10,815        |
| Capital Cost                   | \$2,925,000       | \$5,000,000  | \$10,600,000 | \$21,330,000  |
| Annual Capital (\$/Yr)         | \$260,000         | \$445,000    | \$942,000    | \$1,900,000   |
| Annual O&M (\$/Yr)             | \$432,000         | \$654,000    | \$1,591,000  | \$3,068,000   |
| Total Annual Cost (\$/Yr)      | \$692,000         | \$1,099,000  | \$2,533,000  | \$4,968,000   |
| Water Cost (\$/AFY Production) | \$641             | \$508        | \$469        | \$459         |

# Summary

Using reverse osmosis, the saline groundwater from the shallow aquifer was desalted. The product water would be suitable for use as irrigation water.

The RO demonstration plant operated periodically throughout the 2000 and continuously throughout the 2002 irrigation seasons using two different feedwater sources to produce the permeate. During 2000 the water used in the RO demonstration plant came from the on-farm tile drain system that was installed by the farmers to keep the saline groundwater below the crop root zone and to transport the drainage water away from the crops. During 2002, two shallow wells were used to supply water to the RO demonstration plant. The water from the two wells was 57 % less salty than that of the tile drain system.

The RO demonstration plant recovered up to 75% of the feed water and rejected as much as 90% of the organics and 97% of the TDS. Alum was injected ahead of the filter system to promote coagulation and to increase solid settling to obtain RO feedwater with an acceptable SDI. The prefiltration did not reduce the TOC concentration in the raw water.

The RO Demonstration Project has shown that it is technically feasible to reclaim agricultural drainage water in the San Joaquin Valley using reverse osmosis. A suitable method for disposing of the concentrate must be determined before implementation is possible.

## Future Study

Future studies should focus mainly on RO process brine disposal. **Table 9** shows the brine concentrate quality data captured during the pilot study.

**Table 9. Concentrate Quality**

| <b>Constituent<br/>(mg/L)</b> | <b>Field<br/>Data</b> |
|-------------------------------|-----------------------|
| Calcium                       | 1,215                 |
| Magnesium                     | 218                   |
| Sodium                        | 3,200                 |
| Potassium                     | 0                     |
| Ammonium                      | 0                     |
| Barium                        | 0                     |
| Strontium                     | 9                     |
| Iron                          | 5                     |
| Aluminum                      | 0                     |
| Bicarbonate                   | 725                   |
| Chloride                      | 5,238                 |
| Sulfate                       | 3,192                 |
| Fluoride                      | 0                     |
| Nitrate                       | 0                     |
| Phosphate                     | 0                     |
| Silica                        | 99                    |
| pH (pH units)                 | 7.20                  |
| TDS                           | 12,079                |

There are multiple ways to dispose of RO concentrate, including:

- Evaporation Ponds
- Deep Well Injection
- Disposal to a Body of Water (i.e. Ocean or River)
- Enhanced Recovery (Zero Liquid Discharge)

### **Evaporation Ponds**

Disposal of wastewater (including desalting concentrate) via evaporation ponds has been used for many years. There are several design aspects of evaporation ponds that need to be considered:

- The net evaporation rate (gross evaporation less precipitation and decrease in evaporation rate as TDS increases)
- Land requirements—the area required depends on the volume of water requiring disposal, net evaporation rate, and topography (a level site would require the least land for a given evaporation surface need)
- Number and size of ponds
- Impermeable lining for minimizing leakage into underlying groundwater
- Impacts of trace elements (i.e. sodium) on water flow and biological resources

Assuming a net evaporation rate of 5 feet per year, **Table 10** shows the surface areas of evaporation ponds that would be needed for various treatment plant sizes.

**Table 10. Needed Evaporation Pond Area for Varying Production Rates**

| Plant Productions (MGD)   | 1   | 2   | 5     | 10    |
|---------------------------|-----|-----|-------|-------|
| Concentrate (AFY)         | 326 | 637 | 1,587 | 3,178 |
| Evaporation Area (acres)  | 65  | 127 | 317   | 636   |
| Number of Ponds           | 2   | 4   | 8     | 16    |
| Size of Each Pond (acres) | 35  | 35  | 40    | 40    |
| Total Pond Area (acres)   | 70  | 140 | 320   | 640   |
| Total Area Needed (acres) | 75  | 150 | 345   | 690   |

A typical pond may have a total depth of 12 ft (including 2 ft of freeboard) and side slopes of 3 to 1.

### Deep Well Injection

An alternative to evaporation ponds is deep well injection (DWI). DWI consists of drilling a well into an aquifer that does not contain usable water to dispose of the

concentrate. The aquifer needs to be deep enough so as not to interfere with usable groundwater.

### **Disposal to a Body of Water**

Another alternative is to dispose of concentrate to a body of water. Typical bodies of water used for disposal include the ocean or nearby rivers and streams. Since this project takes place inland from the ocean, a pipeline would have to be constructed to carry the concentrate from the treatment site.

In order to dispose to a body of water like a river or stream, state and local regulatory agencies insist that the water quality be nontoxic to whatever wildlife may inhabit the waterway. Typical RO waste streams are high in TDS concentration and are difficult to dispose of in a body of water.

### **Enhanced Recovery**

By further treating the concentrate or enhancing the recovery, more useable water and less concentrate is produced. At this point, the brine becomes a highly concentrated waste that can be either disposed of or precipitated for salt recovery.

### ***Secondary RO Treatment***

Depending on the TDS concentration and the ionic makeup of the concentrate, more usable water can be recovered using a second RO unit. However, since the concentrate from the primary RO treatment is saturated in scaling minerals, it must first be treated to remove these minerals before secondary RO treatment.

### ***Zero Liquid Discharge (ZLD)***

ZLD is another form of enhanced recovery. This can be achieved by using equipment such as brine



concentrators and/or crystallizers to remove essentially all of the water from the concentrate. The TDS that was dissolved in the original raw water are recovered as relatively dry salts. (see **Figure 18**).

**Figure 18: Enhanced Recovery Block Flow Diagram**

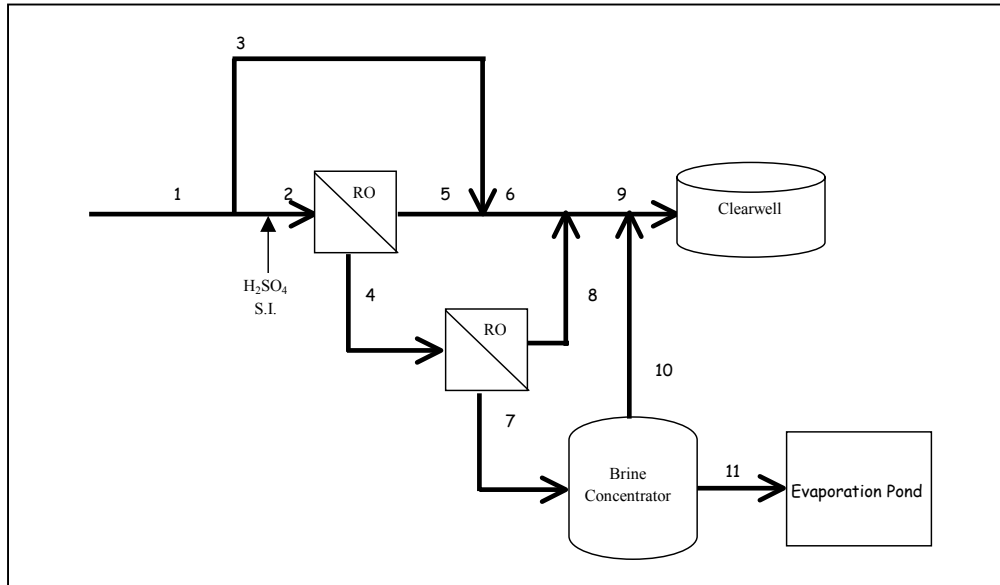

| Stream | 1      | 2     | 3     | 4      | 5       | 6                 | Y <sub>1</sub> %* |
|--------|--------|-------|-------|--------|---------|-------------------|-------------------|
| gpm    | 782    | 707   | 75    | 177    | 530     | 605               | 75%               |
| TDS    | 3,848  | 3,861 | 3,848 | 14,936 | 170     | 626               |                   |
| Stream | 7      | 8     | 9     | 10     | 11      | Y <sub>2</sub> %* | Y <sub>0</sub> %* |
| gpm    | 88.4   | 88    | 772   | 78     | 10      | 50%               | 98.7%             |
| TDS    | 28,340 | 1,532 | 668   | 20     | 240,000 |                   |                   |

\*Y = Percent recovery for each stage of production ("1" & "2") and overall production ("o").

Typically, what's left over after the enhanced recovery process is a highly concentrated sludge. This sludge can be disposed of in drying beds or evaporation ponds to remove what little liquid remains. Once dry, the solid can be hauled off for disposal. Assuming a sludge handling cost of \$53/ton<sup>6</sup>, the annual cost to remove the sludge would approximate \$283,000 dollars for 5,300 tons of sludge waste.

<sup>6</sup> Waste disposal estimate provided by J Torres Company.

# Appendix A – 2000 Demonstration Plant Data

**Table A.1 – Water Quality Analysis - Feed**

| <b>Feed Stream</b>    |              | 1/6/2000 | 8/8/2000 | 8/15/2000 | 8/24/2000 | 8/31/2000 | 9/8/2000 |
|-----------------------|--------------|----------|----------|-----------|-----------|-----------|----------|
| Dissolved Bicarbonate | as ion       |          | 370      | 206       | 373       | 346       | 366      |
| Dissolved Carbonate   | as ion       |          | 1        | 1         | 2         | 1         | <1       |
| Dissolved Chloride    |              | 3990     | 2610     |           |           |           | 2380     |
| EC                    | μS/cm @ 25 C | 13700    | 10200    | 4880      | 9890      | 9650      | 9880     |
| Dissolved Barium      |              | 0.183    | 0.13     |           |           |           | 0.116    |
| Dissolved Boron       |              | 5.8      | 5.24     |           |           |           | 4.89     |
| Dissolved Calcium     |              | 1090     | 696      | 329       | 663       | 702       | 725      |
| Dissolved Fluoride    |              | 0.8      |          |           |           |           |          |
| Dissolved Iron        |              |          |          |           |           |           |          |
| Dissolved Magnesium   |              | 180      | 121      | 49        | 108       | 113       | 130      |
| Dissolved Nitrate     | as N         | 7        | 53       |           |           |           |          |
| Dissolved Nitrite     | as N         |          | 0.03     |           |           |           |          |
| DOC                   | as C         |          | 4.5      |           |           |           |          |
| Dissolved Phosphate   | as P         |          |          |           |           |           |          |
| Dissolved Potassium   |              | 9.8      |          |           |           |           |          |
| Dissolved Selenium    |              | 0.033    | 0.04     |           |           |           | 0.04     |
| Dissolved Silica      |              | 46       | 54       |           |           |           | 29       |
| Dissolved Sodium      |              | 1960     | 1530     | 705       | 1460      | 1410      | 1550     |
| Dissolved Strontium   |              | 8.03     | 6.99     |           |           |           | 6.62     |
| Dissolved Sulfate     |              | 1540     | 1420     |           |           |           | 1390     |
| Hardness              | as CaCO3     | 3484     | 2237     | 1023      | 2101      | 2219      | 2346     |
| Hydroxide             | as CaCO3     |          | <1       | <1        | <1        | <1        | <1       |
| pH                    | pH units     | 7.8      | 7.27     | 7.45      | 7.61      | 7.18      | 7.3      |
| Total Alkalinity      | as CaCO3     | 425      | 371      | 207       | 374       | 346       | 366      |
| TDS                   |              | 9430     | 7010     | 3160      | 6750      | 6730      | 6840     |
| UV254                 | absorb./cm   | 0.171    | 0.149    |           |           |           | 0.117    |
| Total Barium          |              |          |          |           |           |           |          |
| Total Calcium         |              |          |          |           |           |           |          |
| Total Iron            |              |          |          |           |           |           |          |
| Total Magnesium       |              |          |          |           |           |           |          |
| TOC as C              | as C         | 3.9      |          |           |           |           | 3.7      |
| Total Potassium       |              |          |          |           |           |           |          |
| Total Selenium        |              |          |          |           |           |           |          |
| Total Silica          |              |          |          |           |           |           |          |
| Total Sodium          |              |          |          |           |           |           |          |
| Total Strontium       |              |          |          |           |           |           |          |
| TSS                   |              | 6        | 4        |           |           |           | 2        |
| Turbidity             | NTU          | 1.7      | 1.4      | 45.4      | 10.3, 11  | 4.8       | <1       |

**Table A.2 – Water Quality Analysis - Filtrate**

| <b>Filtrate Stream</b> |                      | 1/6/2000 | 8/8/2000 | 8/15/2000 | 8/24/2000 | 8/31/2000 | 9/8/2000 |
|------------------------|----------------------|----------|----------|-----------|-----------|-----------|----------|
| Dissolved Bicarbonate  | as ion               |          | 370      | 203       | 372       | 345       | 366      |
| Dissolved Carbonate    | as ion               |          | 1        | 1         | 1         | 1         | 1        |
| Dissolved Chloride     |                      |          | 2610     |           |           |           | 2490     |
| EC                     | μS/cm @ 25 C         |          | 10200    | 4650      | 9900      | 9650      | 9880     |
| Dissolved Barium       |                      |          | 0.13     |           |           |           | 0.108    |
| Dissolved Boron        |                      |          | 5.4      |           |           |           | 4.4      |
| Dissolved Calcium      |                      |          | 685      | 330       | 679       | 698       | 726      |
| Dissolved Fluoride     |                      |          |          |           |           |           |          |
| Dissolved Iron         |                      |          |          |           |           |           |          |
| Dissolved Magnesium    |                      |          | 124      | 50        | 110       | 113       | 97.3     |
| Dissolved Nitrate      | as N                 |          | 52       |           |           |           |          |
| Dissolved Nitrite      | as N                 |          | 0.03     |           |           |           |          |
| DOC                    | as C                 |          | 6.7      |           |           |           |          |
| Dissolved Phosphate    | as P                 |          |          |           |           |           |          |
| Dissolved Potassium    |                      |          |          |           |           |           |          |
| Dissolved Selenium     |                      |          | 0.039    |           |           |           |          |
| Dissolved Silica       |                      |          | 53       |           |           |           | 41.9     |
| Dissolved Sodium       |                      |          | 1620     | 717       |           | 1420      | 1540     |
| Dissolved Strontium    |                      |          | 6.94     |           |           |           | 6.84     |
| Dissolved Sulfate      |                      |          | 1430     |           |           |           | 1400     |
| Hardness               | as CaCO <sub>3</sub> |          | 2221     | 1030      | 2149      | 2209      | 2220     |
| Hydroxide              | as CaCO <sub>3</sub> |          | <1       | <1        | <1        | <1        | <1       |
| pH                     | pH units             |          | 7.28     | 7.46      | 7.55      | 7.19      | 7.2      |
| Total Alkalinity       | as CaCO <sub>3</sub> |          | 371      | 204       | 373       | 346       | 367      |
| TDS                    |                      |          | 7000     | 3140      |           |           |          |
| UV254                  | absorb./cm           |          | 0.141    |           |           |           | 0.116    |
| Total Barium           |                      |          |          |           |           |           |          |
| Total Calcium          |                      |          |          |           |           |           |          |
| Total Iron             |                      |          |          |           |           |           |          |
| Total Magnesium        |                      |          |          |           |           |           |          |
| TOC as C               | as C                 |          |          |           |           |           | 3.6      |
| Total Potassium        |                      |          |          |           |           |           |          |
| Total Selenium         |                      |          |          |           |           |           |          |
| Total Silica           |                      |          |          |           |           |           |          |
| Total Sodium           |                      |          |          |           |           |           |          |
| Total Strontium        |                      |          |          |           |           |           |          |
| TSS                    |                      |          |          |           |           |           | 1        |
| Turbidity              | NTU                  |          |          | <1        | <1        | <1        | <1       |

**Table A.3 – Water Quality Analysis - Permeate**

| <b>DWR Bryte Laboratory Analysis Results for Buena Vista Project</b> |              | Note: all results are in mg/L unless otherwise stated |          |           |           |           |          |
|--|--------------|---|----------|-----------|-----------|-----------|----------|
| <b>Permeate Stream</b>   |              | 1/6/2000  | 8/8/2000 | 8/15/2000 | 8/24/2000 | 8/31/2000 | 9/8/2000 |
| Dissolved Bicarbonate  | as ion       |   |          |           | 18        | 10        | 10       |
| Dissolved Carbonate  | as ion       |   |          |           | <1        | <1        | <1       |
| Dissolved Chloride   |              |   |          |           |           |           | 93       |
| EC   | μS/cm @ 25 C |   |          |           | 679       | 389       | 387      |
| Dissolved Barium   |              |   |          |           |           |           | <0.05    |
| Dissolved Boron  |              |   |          |           |           |           | 5.2      |
| Dissolved Calcium  |              |   |          |           | 6         | 6         | 8        |
| Dissolved Fluoride   |              |   |          |           |           |           |          |
| Dissolved Iron   |              |   |          |           |           |           |          |
| Dissolved Magnesium  |              |   |          |           | <1        | 2         | <1       |
| Dissolved Nitrate  | as N         |   |          |           |           |           |          |
| Dissolved Nitrite  | as N         |   |          |           |           |           |          |
| DOC  | as C         |   |          |           |           |           |          |
| Dissolved Phosphate  | as P         |   |          |           |           |           |          |
| Dissolved Potassium  |              |   |          |           |           |           |          |
| Dissolved Selenium   |              |   |          |           |           |           | 0.002    |
| Dissolved Silica   |              |   |          |           |           |           | 0.4      |
| Dissolved Sodium   |              |   |          |           | 125       | 68        | 80       |
| Dissolved Strontium  |              |   |          |           |           |           | 0.055    |
| Dissolved Sulfate  |              |   |          |           |           |           | 12       |
| Hardness   | as CaCO3     |   |          |           | 18        | 23        | 21       |
| Hydroxide  | as CaCO3     |   |          |           | <1        | <1        | <1       |
| pH   | pH units     |   |          |           | 6.3       | 6.04      | 6.2      |
| Total Alkalinity   | as CaCO3     |   |          |           | 18        | 10        | 10       |
| TDS  |              |   |          |           | 343       | 199       | 194      |
| UV254  | absorb./cm   |   |          |           |           |           | 0.002    |
| Total Barium   |              |   |          |           |           |           |          |
| Total Calcium  |              |   |          |           |           |           |          |
| Total Iron   |              |   |          |           |           |           |          |
| Total Magnesium  |              |   |          |           |           |           |          |
| TOC as C   | as C         |   |          |           |           |           | 0.2      |
| Total Potassium  |              |   |          |           |           |           |          |
| Total Selenium   |              |   |          |           |           |           |          |
| Total Silica   |              |   |          |           |           |           |          |
| Total Sodium   |              |   |          |           |           |           |          |
| Total Strontium  |              |   |          |           |           |           |          |
| TSS  |              |   |          |           |           |           |          |
| Turbidity  | NTU          |   |          |           | <1        | <1        | <1       |

**Table A.4 – Water Quality Analysis - Concentrate**

| <b>DWR Bryte Laboratory Analysis Results for Buena Vista Project</b> |                      | 1/6/2000 | 8/8/2000 | 8/15/2000 | 8/24/2000 | 8/31/2000 | 9/8/2000 |
|--|----------------------|----------|----------|-----------|-----------|-----------|----------|
| <b>Concentrate Stream</b>  |                      |          |          |           |           |           |          |
| Dissolved Bicarbonate  | as ion               |          |          |           |           |           |          |
| Dissolved Carbonate  | as ion               |          |          |           |           |           |          |
| Dissolved Chloride   |                      |          |          |           |           |           | 6040     |
| EC   | μS/cm @ 25 C         |          |          |           | 17700     |           | 18000    |
| Dissolved Barium   |                      |          |          |           |           |           | 0.207    |
| Dissolved Boron  |                      |          |          |           |           |           | 8.7      |
| Dissolved Calcium  |                      |          |          |           |           |           |          |
| Dissolved Fluoride   |                      |          |          |           |           |           |          |
| Dissolved Iron   |                      |          |          |           |           |           |          |
| Dissolved Magnesium  |                      |          |          |           |           |           |          |
| Dissolved Nitrate  | as N                 |          |          |           |           |           |          |
| Dissolved Nitrite  | as N                 |          |          |           |           |           |          |
| DOC  | as C                 |          |          |           |           |           |          |
| Dissolved Phosphate  | as P                 |          |          |           |           |           |          |
| Dissolved Potassium  |                      |          |          |           |           |           |          |
| Dissolved Selenium   |                      |          |          |           |           |           | 0.078    |
| Dissolved Silica   |                      |          |          |           |           |           | 9.6      |
| Dissolved Sodium   |                      |          |          |           |           |           |          |
| Dissolved Strontium  |                      |          |          |           |           |           | 12.9     |
| Dissolved Sulfate  |                      |          |          |           |           |           | 2720     |
| Hardness   | as CaCO <sub>3</sub> |          |          |           |           |           |          |
| Hydroxide  | as CaCO <sub>3</sub> |          |          |           |           |           |          |
| pH   | pH units             |          |          |           |           |           | 7.2      |
| Total Alkalinity   | as CaCO <sub>3</sub> |          |          |           |           |           |          |
| TDS  |                      |          |          |           | 13100     |           | 13400    |
| UV254  | absorb./cm           |          |          |           |           |           | 0.235    |
| Total Barium   |                      |          |          |           |           |           |          |
| Total Calcium  |                      |          |          |           |           |           |          |
| Total Iron   |                      |          |          |           |           |           |          |
| Total Magnesium  |                      |          |          |           |           |           |          |
| TOC as C   | as C                 |          |          |           |           |           | 8.6      |
| Total Potassium  |                      |          |          |           |           |           |          |
| Total Selenium   |                      |          |          |           |           |           |          |
| Total Silica   |                      |          |          |           |           |           |          |
| Total Sodium   |                      |          |          |           |           |           |          |
| Total Strontium  |                      |          |          |           |           |           |          |
| TSS  |                      |          |          |           |           |           |          |
| Turbidity  | NTU                  |          |          |           | 10.2      |           | <1       |

**Table A.5 – Year 2000 Filter Performance Data**

| Date      | Train | Operation | Op Time (min) | P <sub>in</sub> (psi) | P <sub>IS</sub> (psi) | P <sub>out</sub> (psi) | SDI | EC (mS) | pH   |
|-----------|-------|-----------|---------------|-----------------------|-----------------------|------------------------|-----|---------|------|
| 6/27/2000 | 2     | -         | -             | 63                    | 63                    | 62.5                   | 3.1 | -       | -    |
| 6/28/2000 | 2     | -         | -             | 62                    | 62                    | 60                     | 2.9 | 6.75    | -    |
| 6/29/2000 | 2     | -         | -             | 61                    | 62                    | 60                     | 2.2 | 7.67    | -    |
| 6/30/2000 | 2     | -         | -             | -                     | -                     | -                      | -   | 7.28    | 7.35 |
| 7/3/2000  | 2     | -         | -             | 62                    | 63                    | 61                     | 2.9 | 7.64    | 8.78 |
| 7/4/2000  | 2     | -         | -             | 68                    | 55                    | 52                     | 1.8 | 7.75    | 8.29 |
| 7/5/2000  | 2     | Backwash  | 20            | 73                    | 38                    | 34                     | 1.8 | 7.26    | 8.35 |
| 7/5/2000  | 1     | Online    | -             | 62                    | 62                    | 62                     | 2.7 | -       | -    |
| 7/6/2000  | 1     | -         | -             | 61                    | 61                    | 60                     | 3   | 5.58    | 8.45 |
| 7/7/2000  | 1     | -         | -             | 62                    | 58                    | 58                     | 3.9 | 4.98    | 8.57 |
| 7/10/2000 | 1     | Backwash  | 20            | 66                    | 42                    | 42                     | NC  | 4.54    | 8.56 |
| 7/10/2000 | 2     | Online    | -             | 62                    | 62                    | 62                     | 3.6 | -       | -    |
| 7/11/2000 | 2     | Backwash  | 20            | 70                    | 47                    | 42                     | NC  | -       | -    |
| 7/11/2000 | 1     | Online    | -             | 60                    | 60                    | 60                     | 3.4 | -       | -    |
| 7/12/2000 | 1     | Backwash  | 20            | 66                    | 30                    | 30                     | 3.4 | -       | -    |
| 7/12/2000 | 1     | Online    | -             | 60                    | 60                    | 60                     | -   | -       | -    |
| 7/13/2000 | 2     | Online    | -             | 60                    | 60                    | 60                     | -   | -       | -    |
| 7/14/2000 | 1     | Online    | -             | 60                    | 60                    | 60                     | -   | -       | -    |
| 7/17/2000 | 1     | -         | -             | 58                    | 56                    | 54                     | 2.1 | 8.28    | 8.80 |
| 7/18/2000 | 1     | -         | -             | 58                    | 54                    | 54                     | 2.9 | 8.00    | 8.58 |



**Table A.5 – Year 2000 Filter Performance Data (cont.)**

| Date      | Train | Operation             | Op Time (min) | P <sub>in</sub> (psi) | P <sub>IS</sub> (psi) | P <sub>out</sub> (psi) | SDI | EC (mS) | pH   |
|-----------|-------|-----------------------|---------------|-----------------------|-----------------------|------------------------|-----|---------|------|
| 7/18/2000 | -     | Took Sample/RO Online | -             | -                     | -                     | -                      | -   | -       | -    |
| 7/19/2000 | 1     | Backwash              | 20            | 58                    | 50                    | 50                     | 1.8 | 6.39    | 8.51 |
| 7/19/2000 | 2     | Online                | -             | 56                    | 52                    | 52                     | -   | -       | -    |
| 7/20/2000 | 2     | Backwash              | 20            | 50                    | 46                    | 30                     | 1.7 | 8.04    | 5.51 |
| 7/20/2000 | 1     | Online                | -             | 58                    | 58                    | 58                     | -   | -       | -    |
| 7/24/2000 | 1     | Backwash              | 20            | 58                    | 48                    | 46                     | 1.7 | 6.77    | 8.50 |
| 7/24/2000 | 2     | Online                | -             | 58                    | 58                    | 56                     | -   | -       | -    |
| 7/25/2000 | 2     | Took Sample           | -             | 56                    | 56                    | 51                     | 1.8 | 8.03    | 8.49 |
| 7/26/2000 | 2     | Backwash              | 20            | 54                    | 50                    | 36                     | -   | -       | -    |
| 7/26/2000 | 1     | Online                | -             | 51                    | 51                    | 51                     | -   | -       | -    |
| 7/27/2000 | 1     | -                     | -             | 52                    | 50                    | 48                     | 2.5 | 7.98    | 8.36 |
| 7/28/2000 | 1     | Backwash              | 20            | 51                    | 41                    | 40                     | 5.1 | 6.04    | 8.48 |
| 7/28/2000 | 2     | Online                | -             | -                     | -                     | -                      | -   | -       | -    |
| 7/31/2000 | 2     | Backwash              | 20            | 50                    | 50                    | 18                     | 4   | 6.80    | 8.46 |
| 7/31/2000 | 1     | Online                | -             | -                     | -                     | -                      | -   | -       | -    |
| 8/1/2000  | 1     | -                     | -             | 60                    | 60                    | 60                     | 3.5 | 7.48    | 8.43 |
| 8/2/2000  | 1     | Backwash              | 20            | 54                    | 48                    | 46                     | 3.2 | 7.31    | 8.10 |
| 8/2/2000  | 2     | Online                | -             | 38                    | 38                    | 36                     | -   | -       | -    |
| 8/3/2000  | 2     | Backwash              | 20            | 44                    | 36                    | 34                     | 2.5 | 8.41    | 8.37 |
| 8/3/2000  | 1     | Online                | -             | 46                    | 46                    | 45                     | -   | -       | -    |

**Table A.5 – Year 2000 Filter Performance Data (cont.)**

| Date      | Train | Operation                 | Op Time (min) | P <sub>in</sub> (psi) | P <sub>IS</sub> (psi) | P <sub>out</sub> (psi) | SDI | EC (mS) | pH   |
|-----------|-------|---------------------------|---------------|-----------------------|-----------------------|------------------------|-----|---------|------|
| 8/4/2000  | 1     | -                         | -             | 42                    | 40                    | 38                     | 2.3 | 8.40    | 8.69 |
| 8/7/2000  | 1     | Backwash                  | 20            | 44                    | 28                    | 26                     | -   | 8.43    | 9.38 |
| 8/8/2000  | 2     | -                         | -             | 44                    | 44                    | 42                     | 2.3 | 8.29    | 4.16 |
| 8/9/2000  | 2     | -                         | -             | 44                    | 42                    | 40                     | 2.2 | 8.30    | 9.00 |
| 8/10/2000 | 2     | Backwash/Irrigation Began | 20            | 46                    | 38                    | 32                     | 2.3 | 8.37    | 9.00 |
| 8/14/2000 | 1     | Backwash                  | 20            | 46                    | 43                    | 42                     | 3.1 | 8.30    | 8.86 |
| 8/15/2000 | 2     |                           |               | 44                    | 42                    | 38                     | 5.0 | 5.08    | 8.57 |
| 8/16/2000 | 2     | Backwash                  | 20            | 48                    | 40                    | 28                     | 3.2 | 8.44    | 8.40 |
| 8/17/2000 | 1     | Online                    |               | 48                    | 46                    | 44                     | 2.9 | 8.77    | 8.46 |
| 8/18/2000 | 1     | -                         | -             | 48                    | 44                    | 42                     |     | 8.65    | 7.51 |
| 8/22/2000 | -     | Load New Membranes        | -             | -                     | -                     | -                      | -   | -       | -    |
| 8/24/2000 | 1     | Sampled                   | -             | 28                    | 28                    | 26                     | 2.6 | 8.68    | 7.39 |
| 8/25/2000 | 2     | Online                    | -             | 28                    | 28                    | 26                     |     | 7.30    | 7.14 |
| 8/28/2000 | 2     | -                         | -             | 26                    | 26                    | 24                     | 2.1 | 6.84    | -    |
| 8/29/2000 | 2     | Backwash                  | 20            | 26                    | 24                    | 20                     | 2.2 | 6.31    | -    |
| 8/30/2000 | -     | 2nd Stage Membranes       | -             | -                     | -                     | -                      | -   | -       | -    |
| 8/31/2000 | 1     | Sampled                   |               | 26                    | 24                    | 22                     | 2.1 | 4.29    | -    |
| 9/6/2000  | 1     | Backwash                  | 20            | -                     | -                     | -                      | -   | -       | -    |
| 9/6/2000  | 2     | Online                    | -             | 26                    | 26                    | 22                     | -   | 0.93    | -    |
| 9/7/2000  | 2     | -                         | -             | 26                    | 26                    | 22                     | -   | 6.09    | -    |

**Table A.5 – Year 2000 Filter Performance Data (cont.)**

| Date      | Train | Operation | Op Time (min) | P <sub>in</sub> (psi) | P <sub>IS</sub> (psi) | P <sub>out</sub> (psi) | SDI | EC (mS) | pH |
|-----------|-------|-----------|---------------|-----------------------|-----------------------|------------------------|-----|---------|----|
| 9/8/2000  | 2     | -         | -             | 26                    | 26                    | 24                     | -   | 3.48    | -  |
| 9/11/2000 | 1     | Online    |               | 26                    | 26                    | 24                     |     | 6.73    |    |
| 9/12/2000 | 1     |           |               | 26                    | 26                    | 24                     |     | 5.13    |    |
| 9/13/2000 | 1     |           |               | 26                    | 26                    | 24                     |     | 5.57    |    |

**Table A.6 – RO Performance Data**

| Date      | Conductivity (mS/s) |      |      |      |      | Pressure (psi) |           |            |      |                      |             | Flow (gpm) |             |
|-----------|---------------------|------|------|------|------|----------------|-----------|------------|------|----------------------|-------------|------------|-------------|
|           | Overall             | P1   | P2   | P3   | P4   | Permeate       | Filter In | Filter Out | Feed | IS                   | Concentrate | Permeate   | Concentrate |
| 8/1/2000  | 1130                | 984  | 1426 | 1420 | 1810 | 3              | 67        | 63         | 206  | 160                  | 154         | 10         | 10          |
| 8/2/2000  | 930                 | 769  | 1357 | 1370 | 1842 | 3              | 75        | 70         | 215  | 160                  | 155         | 10         | 10          |
| 8/3/2000  | 1354                | 1069 | 1874 | 1812 | 2390 | 3              | 41        | 37         | 145  | 105                  | 95          | 9          | 12          |
| 8/4/2000  | 1533                | 1012 | 1806 | 1671 | 2240 | 3              | 38        | 34         | 205  | 165                  | 145         | 11         | 10          |
| 8/7/2000  | 1705                | 1197 | 2080 | 1857 | 2500 | 3              | 44        | 39         | 225  | 185                  | 170         | 12         | 9           |
| 8/8/2000  | 1743                | 1235 | 2130 | 1880 | 2530 | 3              | 42        | 38         | 225  | 160                  | 165         | 8          | 10          |
| 8/9/2000  | 1766                | 1217 | 2080 | 1879 | 2500 | 3              | 40        | 36         | 235  | 185                  | 160         | 10         | 10          |
| 8/10/2000 | 1679                | 1173 | 2020 | 1817 | 2420 | 3              | 34        | 30         | 225  | 180                  | 165         | 10         | 10          |
| 8/14/2000 | 1651                | -    | -    | -    | -    | 3              | -         | -          | 226  | 176                  | 166         | 10         | 10          |
| 8/15/2000 | 657                 | 470  | 780  | 732  | 1009 | 3              | 39        | 37         | 200  | 150                  | 145         | 9          | 12          |
| 8/16/2000 | 1460                | 1030 | 1670 | 1625 | 2120 | 3              | 30        | 30         | 215  | 170                  | 155         | 10         | 9.5         |
| 8/17/2000 | 1768                | 1129 | 1774 | 1712 | 2330 | 3              | 45        | 45         | 225  | 180                  | 165         | 10         | 9.8         |
| 8/18/2000 | 1485                | 1028 | 1552 | 1512 | 2130 | -              | -         | -          | -    | -                    | -           | -          | -           |
| 8/22/2000 | 990                 | 207  | 483  | 2060 | 2820 | -              | -         | -          | -    | <b>New Membranes</b> | -           | -          | -           |
| 8/24/2000 | 717                 | 102  | 336  | 1933 | 2610 | 4              | 27        | 26         | 215  | 200                  | 185         | 10         | 10          |
| 8/25/2000 | 682                 | 95.6 | 321  | 1800 | 2460 | 4              | 25        | 25         | 215  | 195                  | 185         | 10         | 10          |
| 8/28/2000 | 693                 | 90   | 299  | 1009 | 2510 | -              | -         | -          | -    | -                    | -           | -          | -           |
| 8/29/2000 | 623                 | 90.4 | 291  | 1778 | 2460 | 4              | 24        | 23         | 215  | 195                  | 185         | 10         | 10          |
| 8/30/2000 |                     |      |      |      |      | -              | -         | -          | -    | <b>New Membranes</b> | -           | -          | -           |
| 8/31/2000 | 420                 | 93.1 | 273  | 633  | 831  | 4              | 24        | 22         | 200  | 175                  | 150         | 9.5        | 10.5        |
| 9/6/2000  | 430                 | 275  | 410  | 781  | 1027 | 4              | 24        | 24         | 185  | 160                  | 135         | 11         | 10          |
| 9/7/2000  | 394                 | 100  | 303  | 765  | 1130 | 4              | 24        | 24         | 210  | 185                  | 160         | 10         | 10          |
| 9/8/2000  | 350                 | 76.9 | 178  | 570  | 763  | 4              | 25        | 24         | 205  | 175                  | 160         | 10         | 10          |
| 9/11/2000 | 350                 | 101  | 262  | 628  | 856  | 3              | 26        | 26         | 185  | 160                  | 135         | 10         | 10          |
| 9/12/2000 | 436                 | 95.3 | 295  | 689  | 973  | 4              | 62        | 60         | 220  | 195                  | 170         | 10         | 10          |
| 9/13/2000 | 483                 | 98.3 | 300  | 752  | 1150 | 4              | 61        | 61         | 220  | 195                  | 170         | 10         | 10          |

**Table A.7 – Filter Train 1 SDI Data**

| Date      | Train | Operation | Op Time (min) | P <sub>in</sub> (psi) | P <sub>IS</sub> (psi) | P <sub>out</sub> (psi) | SDI | EC (mS) | pH   |
|-----------|-------|-----------|---------------|-----------------------|-----------------------|------------------------|-----|---------|------|
| 7/5/2000  | 1     | Online    | -             | 62                    | 62                    | 62                     | 2.7 | -       | -    |
| 7/6/2000  | 1     | -         | -             | 61                    | 61                    | 60                     | 3   | 5.58    | 8.45 |
| 7/7/2000  | 1     | -         | -             | 62                    | 58                    | 58                     | 3.9 | 4.98    | 8.57 |
| 7/11/2000 | 1     | Online    | -             | 60                    | 60                    | 60                     | 3.4 | -       | -    |
| 7/12/2000 | 1     | Backwash  | 20            | 66                    | 30                    | 30                     | 3.4 | -       | -    |
| 7/17/2000 | 1     | -         | -             | 58                    | 56                    | 54                     | 2.1 | 8.28    | 8.80 |
| 7/18/2000 | 1     | -         | -             | 58                    | 54                    | 54                     | 2.9 | 8.00    | 8.58 |
| 7/19/2000 | 1     | Backwash  | 20            | 58                    | 50                    | 50                     | 1.8 | 6.39    | 8.51 |
| 7/24/2000 | 1     | Backwash  | 20            | 58                    | 48                    | 46                     | 1.7 | 6.77    | 8.50 |
| 7/27/2000 | 1     | -         | -             | 52                    | 50                    | 48                     | 2.5 | 7.98    | 8.36 |
| 7/28/2000 | 1     | Backwash  | 20            | 51                    | 41                    | 40                     | 5.1 | 6.04    | 8.48 |
| 8/1/2000  | 1     | -         | -             | 60                    | 60                    | 60                     | 3.5 | 7.48    | 8.43 |
| 8/2/2000  | 1     | Backwash  | 20            | 54                    | 48                    | 46                     | 3.2 | 7.31    | 8.10 |
| 8/4/2000  | 1     | -         | -             | 42                    | 40                    | 38                     | 2.3 | 8.40    | 8.69 |
| 8/14/2000 | 1     | Backwash  | 20            | 46                    | 43                    | 42                     | 3.1 | 8.30    | 8.86 |
| 8/17/2000 | 1     | Online    | -             | 48                    | 46                    | 44                     | 2.9 | 8.77    | 8.46 |
| 8/24/2000 | 1     | Sampled   | -             | 28                    | 28                    | 26                     | 2.6 | 8.68    | 7.39 |
| 8/31/2000 | 1     | Sampled   | -             | 26                    | 24                    | 22                     | 2.1 | 4.29    | -    |
|           |       |           |               |                       |                       |                        |     |         |      |
| Average   | 2.9   |           |               |                       |                       |                        |     |         |      |
| SD        | 0.80  |           |               |                       |                       |                        |     |         |      |

**Table A.8 – Filter Train 2 SDI Data**

| Date      | Train | Operation                 | Op Time (min) | P <sub>in</sub> (psi) | P <sub>IS</sub> (psi) | P <sub>out</sub> (psi) | SDI | EC (mS) | pH   |
|-----------|-------|---------------------------|---------------|-----------------------|-----------------------|------------------------|-----|---------|------|
| 7/3/2000  | 2     | -                         | -             | 62                    | 63                    | 61                     | 2.9 | 7.64    | 8.78 |
| 7/4/2000  | 2     | -                         | -             | 68                    | 55                    | 52                     | 1.8 | 7.75    | 8.29 |
| 7/5/2000  | 2     | Backwash                  | 20            | 73                    | 38                    | 34                     | 1.8 | 7.26    | 8.35 |
| 7/10/2000 | 2     | Online                    | -             | 62                    | 62                    | 62                     | 3.6 | -       | -    |
| 7/20/2000 | 2     | Backwash                  | 20            | 50                    | 46                    | 30                     | 1.7 | 8.04    | 5.51 |
| 7/25/2000 | 2     | Took Sample               | -             | 56                    | 56                    | 51                     | 1.8 | 8.03    | 8.49 |
| 7/31/2000 | 2     | Backwash                  | 20            | 50                    | 50                    | 18                     | 4   | 6.80    | 8.46 |
| 8/3/2000  | 2     | Backwash                  | 20            | 44                    | 36                    | 34                     | 2.5 | 8.41    | 8.37 |
| 8/8/2000  | 2     | -                         | -             | 44                    | 44                    | 42                     | 2.3 | 8.29    | 4.16 |
| 8/9/2000  | 2     | -                         | -             | 44                    | 42                    | 40                     | 2.2 | 8.30    | 9.00 |
| 8/10/2000 | 2     | Backwash/Irrigation Began | 20            | 46                    | 38                    | 32                     | 2.3 | 8.37    | 9.00 |
| 8/15/2000 | 2     |                           |               | 44                    | 42                    | 38                     | 5.0 | 5.08    | 8.57 |
| 8/16/2000 | 2     | Backwash                  | 20            | 48                    | 40                    | 28                     | 3.2 | 8.44    | 8.40 |
| 8/28/2000 | 2     | -                         | -             | 26                    | 26                    | 24                     | 2.1 | 6.84    | -    |
| 8/29/2000 | 2     | Backwash                  | 20            | 26                    | 24                    | 20                     | 2.2 | 6.31    | -    |
|           |       |                           |               |                       |                       |                        |     |         |      |
| Average   | 2.6   |                           |               |                       |                       |                        |     |         |      |
| SD        | 0.92  |                           |               |                       |                       |                        |     |         |      |

Figure A.9 – Filter Performance Data for Year 2000

Buena Vista Water Storage District  
Agricultural Drainwater Treatment Project

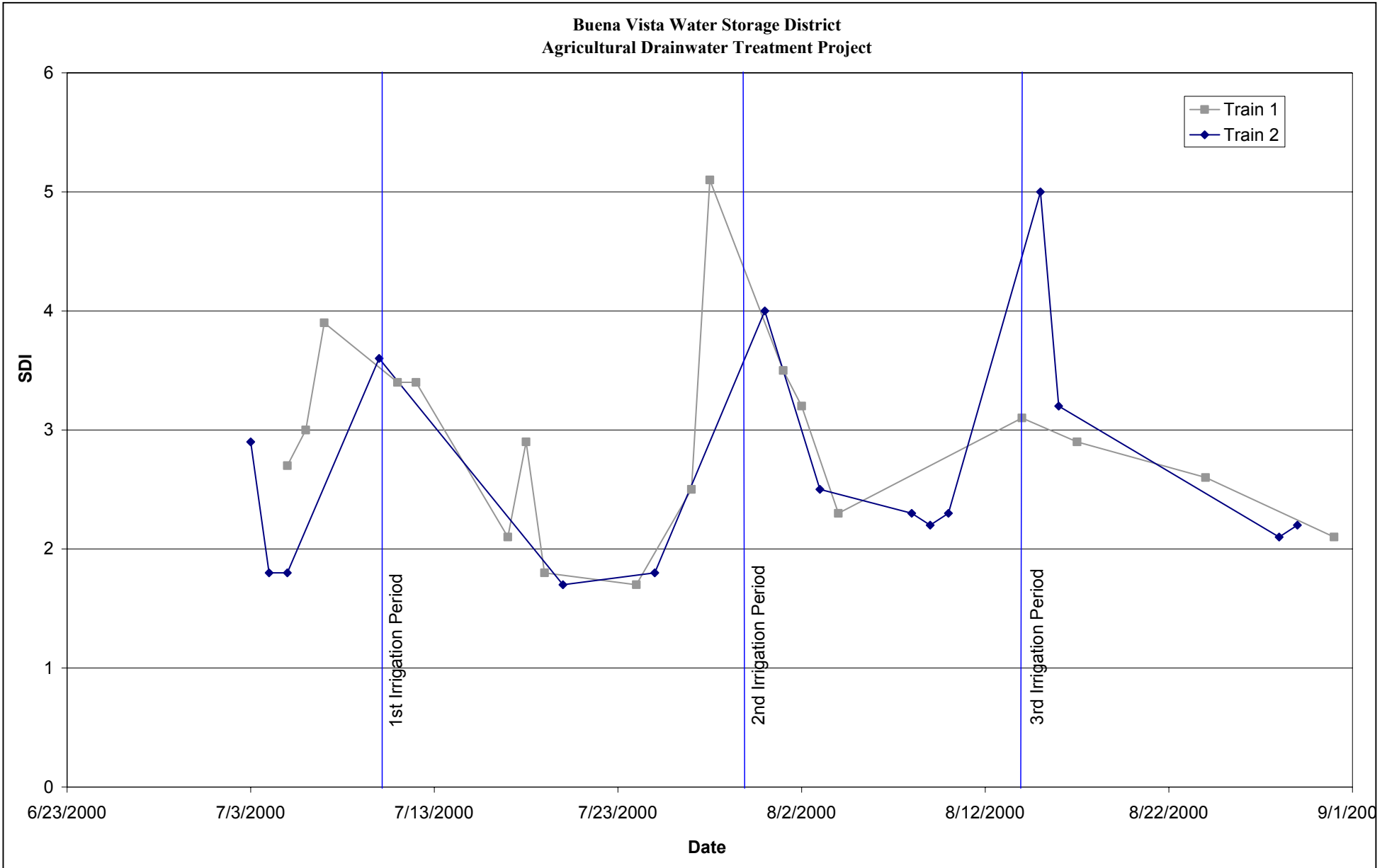

# Appendix B – Laboratory Analytical Data

Table B.1 - Water Quality Analysis - Feed

| <b>DWR Bryte Laboratory Analysis Results for Buena Vista Project</b> |              |          |          |           |           |           |          |           |           |           |          |           |           |           |
|--|--------------|----------|----------|-----------|-----------|-----------|----------|-----------|-----------|-----------|----------|-----------|-----------|-----------|
| Note: all results are in mg/L unless otherwise stated                |              |          |          |           |           |           |          |           |           |           |          |           |           |           |
| <b>Feed Stream</b>   |              | 4/1/2002 | 4/8/2002 | 4/15/2002 | 4/23/2002 | 4/29/2002 | 5/6/2002 | 5/13/2002 | 5/21/2002 | 5/29/2002 | 6/3/2002 | 6/10/2002 | 6/17/2002 | 6/24/2002 |
| Dissolved Bicarbonate  | as ion       |          |          |           |           | 264       |          |           |           |           |          |           |           |           |
| Dissolved Carbonate  | as ion       |          |          |           |           | 1         |          |           |           |           |          |           |           |           |
| Dissolved Chloride   |              |          |          |           |           | 1,530     |          |           |           |           |          |           |           |           |
| EC   | uS/cm @ 25 C |          |          |           |           | 6,550     |          |           |           |           |          |           |           |           |
| Dissolved Barium   |              |          |          |           |           |           |          |           |           |           |          |           |           |           |
| Dissolved Boron  |              |          |          |           |           | 3.6       |          |           |           |           |          |           |           |           |
| Dissolved Calcium  |              |          |          |           |           | 395       |          |           |           |           |          |           |           |           |
| Dissolved Fluoride   |              |          |          |           |           |           |          |           |           |           |          |           |           |           |
| Dissolved Iron   |              |          |          |           |           |           |          |           |           |           |          |           |           |           |
| Dissolved Magnesium  |              |          |          |           |           | 64        |          |           |           |           |          |           |           |           |
| Dissolved Nitrate  | as N         |          |          |           |           |           |          |           |           |           |          |           |           |           |
| Dissolved Nitrite  | as N         |          |          |           |           |           |          |           |           |           |          |           |           |           |
| DOC  | as C         |          |          |           |           | 5.1       |          |           |           |           |          |           |           |           |
| Dissolved Phosphate  | as P         |          |          |           |           |           |          |           |           |           |          |           |           |           |
| Dissolved Potassium  |              |          |          |           |           |           |          |           |           |           |          |           |           |           |
| Dissolved Selenium   |              |          |          |           |           |           |          |           |           |           |          |           |           |           |
| Dissolved Silica   |              |          |          |           |           | 27        |          |           |           |           |          |           |           |           |
| Dissolved Sodium   |              |          |          |           |           | 900       |          |           |           |           |          |           |           |           |
| Dissolved Strontium  |              |          |          |           |           |           |          |           |           |           |          |           |           |           |
| Dissolved Sulfate  |              |          |          |           |           | 908       |          |           |           |           |          |           |           |           |
| Hardness   | as CaCO3     |          |          |           |           | 1,250     |          |           |           |           |          |           |           |           |
| Hydroxide  | as CaCO3     |          |          |           |           | <1        |          |           |           |           |          |           |           |           |
| pH   | pH units     |          |          |           |           | 7.5       |          |           |           |           |          |           |           |           |
| Total Alkalinity   | as CaCO3     |          |          |           |           | 265       |          |           |           |           |          |           |           |           |
| TDS  |              |          |          |           |           | 4,204     |          |           |           |           |          |           |           |           |
| UV254  | absorb./cm   |          |          |           |           | 0.166     |          |           |           |           |          |           |           |           |
| Total Barium   |              |          |          |           |           | <.05      |          |           |           |           |          |           |           |           |
| Total Calcium  |              |          |          |           |           |           |          |           |           |           |          |           |           |           |
| Total Iron   |              |          |          |           |           |           |          |           |           |           |          | 4.84      | 1.16      | 2.57      |
| Total Magnesium  |              |          |          |           |           |           |          |           |           |           |          |           |           |           |
| TOC as C   | as C         |          |          |           | 6.2       | 5.5       | 6        | 8.5       | 6.9       | 7.6       | 7.6      | 10.7      | 10.4      | 5.8       |
| Total Potassium  |              |          |          |           |           |           |          |           |           |           |          |           |           |           |
| Total Selenium   |              |          |          |           |           | 0.019     |          |           |           |           |          |           |           |           |
| Total Silica   |              |          |          |           |           |           |          |           |           |           |          |           |           |           |
| Total Sodium   |              |          |          |           |           |           |          |           |           |           |          |           |           |           |
| Total Strontium  |              |          |          |           |           | 3.6       |          |           |           |           |          |           |           |           |
| TSS  |              | <1       | 3        | 2         | 7         | 4         | 4        | 5         | 9         | 5         | 10       | 2         | 2         | 9         |
| Turbidity  | NTU          | <1       | 16       | 13        | 7         | 17        | 13.8     | 11.2      | 11        | 6         | 30       | 8         | 21        | 22        |



Table B.1 - Water Quality Analysis - Feed (cont.)

| DWR Bryte Laboratory Analysis Results for Buena Vista Project |              |          |          |           |           |           |          |           |           |           |          |           |           |            |            |            |           |            |            |            |           |
|---|--------------|----------|----------|-----------|-----------|-----------|----------|-----------|-----------|-----------|----------|-----------|-----------|------------|------------|------------|-----------|------------|------------|------------|-----------|
| Note: all results are in mg/L unless otherwise stated         |              |          |          |           |           |           |          |           |           |           |          |           |           |            |            |            |           |            |            |            |           |
| Feed Stream   |              | 7/1/2002 | 7/8/2002 | 7/16/2002 | 7/22/2002 | 7/30/2002 | 8/5/2002 | 8/12/2002 | 8/19/2002 | 8/27/2002 | 9/3/2002 | 9/16/2002 | 9/30/2002 | 10/15/2002 | 10/21/2002 | 10/28/2002 | 11/4/2002 | 11/11/2002 | 11/20/2002 | 11/25/2002 | 12/4/2002 |
| Dissolved Bicarbonate   | as ion       | 290      |          |           |           |           |          |           |           |           | 223      |           |           |            |            |            | 264       |            |            |            | 280       |
| Dissolved Carbonate   | as ion       | <1       |          |           |           |           |          |           |           |           | <1       |           |           |            |            |            | <1        |            |            |            | <1        |
| Dissolved Chloride  |              | 1,534    |          |           |           |           |          |           |           |           | 1,190    |           |           |            |            |            | 1,490     |            |            |            | 1,530     |
| EC  | uS/cm @ 25 C | 6,340    |          |           |           |           |          |           |           |           | 6,160    |           |           |            |            |            | 6,120     |            |            |            | 6,330     |
| Dissolved Barium  |              |          |          |           |           |           |          |           |           |           |          |           |           |            |            |            |           |            |            |            |           |
| Dissolved Boron   |              | 3.8      |          |           |           |           |          |           |           |           | 5        |           |           |            |            |            | 3.7       |            |            |            | 4         |
| Dissolved Calcium   |              | 372      |          |           |           |           |          |           |           |           | 266      |           |           |            |            |            | 331       |            |            |            | 358       |
| Dissolved Fluoride  |              |          |          |           |           |           |          |           |           |           |          |           |           |            |            |            |           |            |            |            |           |
| Dissolved Iron  |              |          |          |           |           |           |          |           |           |           |          |           |           |            |            |            |           |            |            |            |           |
| Dissolved Magnesium   |              | 70       |          |           |           |           |          |           |           |           | 49       |           |           |            |            |            | 61        |            |            |            | 66        |
| Dissolved Nitrate   | as N         |          |          |           |           |           |          |           |           |           |          |           |           |            |            |            |           |            |            |            |           |
| Dissolved Nitrite   | as N         |          |          |           |           |           |          |           |           |           |          |           |           |            |            |            |           |            |            |            |           |
| DOC   | as C         | 8        |          |           |           |           |          |           |           |           | 3.6      |           |           |            |            |            | 5.4       |            |            |            | 8         |
| Dissolved Phosphate   | as P         |          |          |           |           |           |          |           |           |           |          |           |           |            |            |            |           |            |            |            |           |
| Dissolved Potassium   |              |          |          |           |           |           |          |           |           |           |          |           |           |            |            |            |           |            |            |            |           |
| Dissolved Selenium  |              |          |          |           |           |           |          |           |           |           |          |           |           |            |            |            |           |            |            |            |           |
| Dissolved Silica  |              | 29       |          |           |           |           |          |           |           |           | 28       |           |           |            |            |            | 28        |            |            |            | 30        |
| Dissolved Sodium  |              | 956      |          |           |           |           |          |           |           |           | 781      |           |           |            |            |            | 883       |            |            |            | 990       |
| Dissolved Strontium   |              |          |          |           |           |           |          |           |           |           |          |           |           |            |            |            |           |            |            |            |           |
| Dissolved Sulfate   |              | 930      |          |           |           |           |          |           |           |           | 760      |           |           |            |            |            | 860       |            |            |            | 906       |
| Hardness  | as CaCO3     | 1,217    |          |           |           |           |          |           |           |           | 866      |           |           |            |            |            | 1,076     |            |            |            | 1,170     |
| Hydroxide   | as CaCO3     | <1       |          |           |           |           |          |           |           |           | <1       |           |           |            |            |            | <1        |            |            |            | <1        |
| pH  | pH units     | 7.2      |          |           |           |           |          |           |           |           | 7        |           |           |            |            |            | 7         |            |            |            | 7.2       |
| Total Alkalinity  | as CaCO3     | 290      |          |           |           |           |          |           |           |           | 223      |           |           |            |            |            | 264       |            |            |            | 280       |
| TDS   |              |          |          |           |           |           |          |           |           |           |          |           |           |            |            |            |           |            |            |            | 3,980     |
| UV254   | absorb/cm    | 0.144    |          |           |           |           |          |           |           |           | 0.191    |           |           |            |            |            | 0.137     |            |            |            | 0.113     |
| Total Barium  |              | <.5      |          |           |           |           |          |           |           |           | <.5      |           |           |            |            |            | <0.5      |            |            |            | <.25      |
| Total Calcium   |              |          |          |           |           |           |          |           |           |           |          |           |           |            |            |            |           |            |            |            |           |
| Total Iron  |              | 1.22     | 1.32     |           |           | 1.68      |          |           |           |           | 4.65     |           |           |            |            |            |           |            |            |            | 1.3       |
| Total Magnesium   |              |          |          |           |           |           |          |           |           |           |          |           |           |            |            |            |           |            |            |            |           |
| TOC as C  | as C         | 6.7      | 6.5      | 6.1       | 6.1       | 6.9       | 6        | 6.1       | 6.8       | 8.5       | 4.3      | 5.5       | 6.5       | 5.5        | 6.9        | 7.5        | 5.6       | 5          | 5.2        | 7.7        | 803       |
| Total Potassium   |              |          |          |           |           |           |          |           |           |           |          |           |           |            |            |            |           |            |            |            |           |
| Total Selenium  |              | 0.026    |          |           |           |           |          |           |           |           | 0.017    |           |           |            |            |            | 0.02      |            |            |            | 0.025     |
| Total Silica  |              |          |          |           |           |           |          |           |           |           |          |           |           |            |            |            |           |            |            |            |           |
| Total Sodium  |              |          |          |           |           |           |          |           |           |           |          |           |           |            |            |            |           |            |            |            |           |
| Total Strontium   |              | 3.21     |          |           |           |           |          |           |           |           | 2.29     |           |           |            |            |            | 2.72      |            |            |            | 2.99      |
| TSS   |              | 3        | <1       | 4         | 4         | 4         | 1        | 4         | 3         | 2         | 11       | 6         | 9         | 4          | 3          | 2          | 3         | 4          | 4          | 9          | 4         |
| Turbidity   | NTU          | 14       | 13       | 10        | 10        | 10        | 10       | 20        | 11        | 7         | 26       | 38        | 34        | 11         | 12         | 15         | 13        | 17         | 18         | 36         | 16        |









Table B.1 - Water Quality Analysis - Concentrate

| <b>DWR Bryte Laboratory Analysis Results for Buena Vista Project</b> |              |          |          |           |           |           |          |           |           |           |          |           |           |           |
|--|--------------|----------|----------|-----------|-----------|-----------|----------|-----------|-----------|-----------|----------|-----------|-----------|-----------|
| Note: all results are in mg/L unless otherwise stated                |              |          |          |           |           |           |          |           |           |           |          |           |           |           |
| <b>Concentrate Stream</b>  |              | 4/1/2002 | 4/8/2002 | 4/15/2002 | 4/23/2002 | 4/29/2002 | 5/6/2002 | 5/13/2002 | 5/21/2002 | 5/29/2002 | 6/3/2002 | 6/10/2002 | 6/17/2002 | 6/24/2002 |
| Dissolved Bicarbonate  | as ion       | 471      | 520      | 883       | 878       | 799       | 736      | 761       | 774       | 714       | 751      | 792       | 801       | 794       |
| Dissolved Carbonate  | as ion       | 1        | 2        | 4         | 6         | 4         | 3        | 6         | 3         | 2         | 2        | 3         | 3         | 2         |
| Dissolved Chloride   |              | 4,270    |          |           |           | 5,350     |          |           | 5,080     |           | 5040     |           |           |           |
| EC   | uS/cm @ 25 C | 15,130   | 12,680   | 18,610    | 20,520    | 19,000    | 18,320   | 17,790    | 18,260    | 17,870    | 17,720   | 18,600    | 18,410    | 18,460    |
| Dissolved Barium   |              |          |          |           |           |           |          |           |           |           |          |           |           |           |
| Dissolved Boron  |              | 5.6      |          |           |           | 6.6       |          |           |           |           | 6.4      |           |           |           |
| Dissolved Calcium  |              | 1130     |          |           |           | 1,270     |          |           |           |           | 1160     |           |           |           |
| Dissolved Fluoride   |              |          |          |           |           |           |          |           |           |           |          |           |           |           |
| Dissolved Iron   |              |          |          |           |           |           |          |           |           |           |          |           |           |           |
| Dissolved Magnesium  |              | 173      |          |           |           | 201       |          |           |           |           | 193      |           |           |           |
| Dissolved Nitrate  | as N         |          |          |           |           |           |          |           |           |           |          |           |           |           |
| Dissolved Nitrite  | as N         |          |          |           |           |           |          |           |           |           |          |           |           |           |
| DOC  | as C         | 40.8     |          |           |           | 13        |          |           |           |           | 13.3     |           |           |           |
| Dissolved Phosphate  | as P         |          |          |           |           |           |          |           |           |           |          |           |           |           |
| Dissolved Potassium  |              |          |          |           |           |           |          |           |           |           |          |           |           |           |
| Dissolved Selenium   |              |          |          |           |           |           |          |           |           |           |          |           |           |           |
| Dissolved Silica   |              | 69       |          |           |           | 82        |          |           |           |           | 83       |           |           |           |
| Dissolved Sodium   |              | 2,130    |          |           |           | 2,860     |          |           |           |           | 2860     |           |           |           |
| Dissolved Strontium  |              |          |          |           |           |           |          |           |           |           |          |           |           |           |
| Dissolved Sulfate  |              | 2,320    |          |           |           | 3,180     |          |           |           | 3,060     |          | 3070      |           |           |
| Hardness   | as CaCO3     | 3,535    |          |           |           | 4,000     |          |           |           |           |          | 3711      |           |           |
| Hydroxide  | as CaCO3     | <1       | <1       | <1        | <1        | <1        | <1       | <1        | <1        | <1        | <1       | <1        | <1        | <1        |
| pH   | pH units     | 7.4      | 7.6      | 7.7       | 7.8       | 7.7       | 7.6      | 7.9       | 7.6       | 7.5       | 7.5      | 7.6       | 7.6       | 7.3       |
| Total Alkalinity   | as CaCO3     | 472      | 522      | 887       | 883       | 803       | 739      | 767       | 777       | 716       | 753      | 795       | 804       | 798       |
| TDS  |              | 9,980    | 8,570    | 12,410    | 11,410    | 12,670    | 11,290   | 11,790    | 11,900    | 11,990    | 11,870   | 12,400    | 12,250    | 12,570    |
| UV254  | absorb./cm   | 0.308    |          |           |           | 0.456     |          |           |           |           | 0.328    |           |           |           |
| Total Barium   |              | 0.093    |          |           |           | 0.128     |          |           |           |           | <1       |           |           |           |
| Total Calcium  |              |          |          |           |           |           |          |           |           |           |          |           |           |           |
| Total Iron   |              |          |          |           |           |           |          |           |           |           |          |           |           |           |
| Total Magnesium  |              |          |          |           |           |           |          |           |           |           |          |           |           |           |
| TOC as C   | as C         | 52.1     |          |           | 15.2      | 13.6      | 14.9     | 18.2      | 18.3      | 16.1      | 14.2     | 24.5      | 25.5      | 15.8      |
| Total Potassium  |              |          |          |           |           |           |          |           |           |           |          |           |           |           |
| Total Selenium   |              | 0.052    |          |           |           | 0.057     |          |           |           |           | 0.068    |           |           |           |
| Total Silica   |              |          |          |           |           |           |          |           |           |           |          |           |           |           |
| Total Sodium   |              |          |          |           |           |           |          |           |           |           |          |           |           |           |
| Total Strontium  |              | 11       |          |           |           | 11.7      |          |           |           |           | 10.7     |           |           |           |
| TSS  |              |          |          |           |           | 3         | 6        | 2         | <1        |           | <1       | <1        | <1        | 3         |
| Turbidity  | NTU          | 3        | 3        | <1        | 22        | 26        | 30.1     | <1        | <1        | <1        | <1       | <1        | 1         | <1        |



# Appendix C – Initial RO Projection



Project: BVWSD  
 Prepared By: aeg

Description: Initial RO Projection  
 Type: Single Pass Design

PROJECT SUMMARY

PROCESS FLOW DIAGRAM

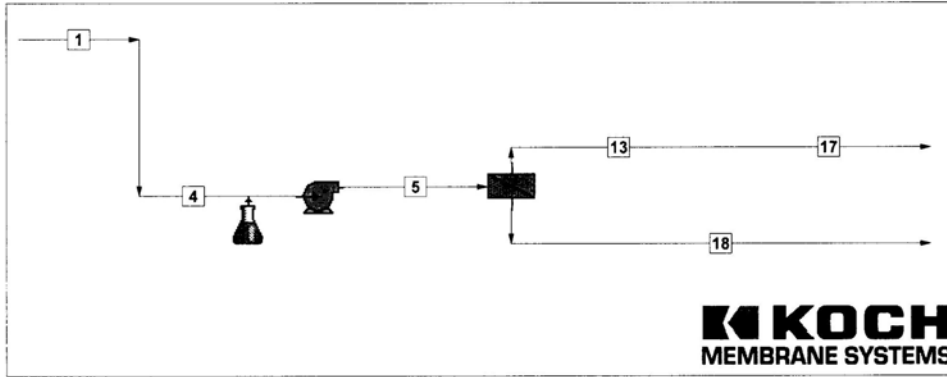

RO Recovery [13/4] = 70.0%  
 Design Temperature = 77.0 Deg F

Overall System Rec [17/(4+15)] = 70.0%

PASS 1  
 Array Recovery [13/4] = 70.0%  
 Element Age = 0.00 Years  
 Fouling Allowance (FA) = 0.0%

| Bank Element Type | Tubes /Bank | Elem /Tube | Avg Flux (GFD) |
|-------------------|-------------|------------|----------------|
| 1 TFC 4820HR      | 2           | 6          | 15.6           |
| 2 TFC 4821ULP     | 1           | 6          | 11.5           |
| System/Pass Total |             |            | 14.2           |

| Stream | Pressure (Psig) | Flow Rate (USGPM) | TDS (mg/L) | 180C Hardness (CaCO3) | Chloride (mg/L) |
|--------|-----------------|-------------------|------------|-----------------------|-----------------|
| 1      | 0.0             | 20.0              | 5947.65    | 2036.2                | 2364.0          |
| 4      | 0.0             | 20.0              | 5947.65    | 2036.2                | 2364.0          |
| 5      | 217.5           | 20.0              | 5969.09    | 2036.2                | 2364.0          |
| 13     | 0.0             | 14.0              | 228.51     | 33.5                  | 110.6           |
| 17     | 0.0             | 14.0              | 228.51     | 33.5                  | 110.6           |
| 18     | 186.2           | 6.0               | 19363.89   | 6709.1                | 7621.9          |

Project: BVWSD  
 Prepared By: aeg

Description: Initial RO Projection  
 Type: Single Pass Design

ARRAY SUMMARY - PASS 1

Permeate Flow 14.0 USGPM Temp (Design/Avg) 77.0/ 77.0 Deg F  
 Pass Recovery 70.0 % Fouling Allowance (FA) 0.0 %  
 Inlet Pres w/o FA 217.5 Psig Conc. Pres w/o FA 186.2 Psig  
 Inlet Pres w/FA 217.5 Psig

| Bank | Element Type | Tubes /Bank (#) | Elms /Tube (#) | Elms /Bank (#) | Elem Age (Yr) | Boost Pressure (Psig) | Manifold Loss (Psig) | Perm Back Pressure (Psig) |
|------|--------------|-----------------|----------------|----------------|---------------|-----------------------|----------------------|---------------------------|
| 1    | TFC 4820HR   | 2               | 6              | 12             | 0.00          | 0.0                   | 0.0                  | 10.0                      |
| 2    | TFC 4821ULP  | 1               | 6              | 6              | 0.00          | 0.0                   | 0.0                  | 0.0                       |

| Bank   | Total Feed (GPM) | Tube Feed (GPM) | Total Conc. (GPM) | Tube Conc. (GPM) | Avg Flux (GFD) | Inlet Pres (Psig) | Avg NDP (Psig) | Bank DP (Psig) | Final Element Beta |
|--------|------------------|-----------------|-------------------|------------------|----------------|-------------------|----------------|----------------|--------------------|
| 1      | 20.0             | 10.0            | 9.9               | 4.9              | 15.6           | 217.5             | 121.5          | 13.4           | 1.080              |
| 2      | 9.9              | 9.9             | 6.0               | 6.0              | 11.5           | 204.0             | 62.9           | 17.8           | 1.039              |
| System |                  |                 |                   |                  | 14.2           |                   |                |                |                    |

| Stream Number       | Net Feed (mg/L) | RO Inlet (mg/L) | Conc. (mg/L) | Permeate (mg/L) |
|---------------------|-----------------|-----------------|--------------|-----------------|
| Concentration       | 4               | 5               | 18           | 13              |
| Ca++                | 675.00          | 675.00          | 2224.06      | 11.12           |
| Mg++                | 85.13           | 85.13           | 280.50       | 1.40            |
| Na+                 | 1327.00         | 1327.00         | 4252.88      | 73.05           |
| K+                  | 4.07            | 4.07            | 12.92        | 0.28            |
| NH4+                | 0.10            | 0.10            | 0.30         | 0.01            |
| Sr++                | 6.22            | 6.22            | 20.49        | 0.10            |
| Ba++                | 0.15            | 0.15            | 0.49         | 0.00            |
| Fe++                | 0.45            | 0.45            | 1.48         | 0.01            |
| Mn++                | 1.00            | 1.00            | 3.29         | 0.02            |
| CO3--               | 0.00            | 0.13            | 0.42         | 0.00            |
| HCO3-               | 292.00          | 220.02          | 691.59       | 18.04           |
| SO4--               | 1303.00         | 1359.66         | 4484.91      | 20.27           |
| Cl-                 | 2364.00         | 2364.00         | 7621.86      | 110.63          |
| NO3-                | 7.68            | 7.68            | 22.61        | 1.28            |
| F-                  | 1.53            | 1.53            | 5.00         | 0.04            |
| SiO2                | 28.90           | 28.90           | 92.98        | 1.44            |
| CO2                 | 4.74            | 56.60           | 56.60        | 56.52           |
| Sum of Ions         | 6096.23         | 6081.04         | 19715.79     | 237.69          |
| TDS (180 C)         | 5947.65         | 5969.09         | 19363.89     | 228.51          |
| pH                  | 8.00            | 6.80            | 7.30         | 5.71            |
| Hardness (as CaCO3) | 2036.22         | 2036.22         | 6709.15      | 33.54           |
| Osm Pressure (Psig) | 51.62           | 51.35           | 165.68       | 2.35            |
| Langlier Index      | 1.76            | 0.43            | 1.94         | -3.65           |
| Stiff-Davis Index   | 1.32            | 0.00            | 1.02         | ---             |

Membrane data file version: Jul-27-2001  
 Please review the Design Notes & Warnings page attached.  
 Concentrate exceeds solubility limit - see warnings sheet.

Project: BVWSD  
Prepared By: aeg

Description: Initial RO Projection  
Type: Single Pass Design

CHEMICAL ADDITION

14.9 lb/day of 93.2% Sulfuric Acid (H2SO4) is required to achieve the target pH in stream [5].

CONCENTRATE SATURATION DATA - STREAM 18

|                               |   |       |                                |
|-------------------------------|---|-------|--------------------------------|
| Langlier Index                | = | 1.937 | <== Warning: Scaling Potential |
| Stiff-Davis Index             | = | 1.017 | <== Warning: Scaling Potential |
| Ratio [Ca][SO4] to Ksp(CaSO4) | = | 2.69  | <== Warning!                   |
| Ratio [Ca][F]^2 to Ksp(CaF2)  | = | 1.69  | <== Warning!                   |
| Ratio [Ba][SO4] to Ksp(BaSO4) | = | 41.88 | <== Warning!                   |
| Ratio [Sr][SO4] to Ksp(SrSO4) | = | 1.10  | <== Warning!                   |

DESIGN WARNINGS - PASS 1: None

APPROXIMATE PUMPING POWER REQUIREMENTS (kW)

|   |      |
|---|------|
| Feed pumping power (w/FA) @65.0% efficiency | 2.91 |
| Interbank pumping power @65.0% efficiency   | 0.00 |

NOTE

This projection is the anticipated performance and is based on nominal properties of the elements, with manifold losses as included.

The fouling allowance option (if included) increases the required 'clean water' net driving pressure by the stated percentage. Program default values are estimates only, and may not be representative of the actual fouling potential of the water source.

This software is provided by Koch Membrane Systems, Inc as a service. The projections are based upon input by the User, and assume that sound engineering principles and practices have been followed.

This printout should not be considered a warranty or guarantee unless accompanied by a statement to that effect from Koch Membrane Systems, Inc.

Project: BVWSD  
 Prepared By: aeg

Description: Initial RO Projection  
 Type: Single Pass Design

FEED STREAM SUMMARY

| Stream Name    | Type         | Percent of Total | Stream Flow Rate (USGPM) | Temperature Design (Deg F) | Temperature Average (Deg F) |
|----------------|--------------|------------------|--------------------------|----------------------------|-----------------------------|
| 1 Feed 1       | Brackish Wel | 100.0            | 20                       | 77.0                       | 77.0                        |
| 2 Feed 2       | Other        | 0.0              | 0                        | 77.0                       | 77.0                        |
| 3 Feed 3       | Other        | 0.0              | 0                        | 77.0                       | 77.0                        |
| 4 Net Feed     | Other        | 100.0            | 20                       | 77.0                       | 77.0                        |
| 5 Treated Feed | Other        | 100.0            | 20                       | 77.0                       | 77.0                        |

CHEMICAL ADDITION

To achieve the target pH in stream [5], 14.9 lb/day of 93.2% Sulfuric Acid (H2SO4) is required.

FEED STREAM COMPOSITIONS

| Stream Number       | 1       | 2      | 3      | 4       | 5       |
|---------------------|---------|--------|--------|---------|---------|
| Concentration       | (mg/L)  | (mg/L) | (mg/L) | (mg/L)  | (mg/L)  |
| Ca++                | 675.00  | 0.00   | 0.00   | 675.00  | 675.00  |
| Mg++                | 85.13   | 0.00   | 0.00   | 85.13   | 85.13   |
| Na+                 | 1327.00 | 0.00   | 0.00   | 1327.00 | 1327.00 |
| K+                  | 4.07    | 0.00   | 0.00   | 4.07    | 4.07    |
| NH4+                | 0.10    | 0.00   | 0.00   | 0.10    | 0.10    |
| Sr++                | 6.22    | 0.00   | 0.00   | 6.22    | 6.22    |
| Ba++                | 0.15    | 0.00   | 0.00   | 0.15    | 0.15    |
| Fe++                | 0.45    | 0.00   | 0.00   | 0.45    | 0.45    |
| Mn++                | 1.00    | 0.00   | 0.00   | 1.00    | 1.00    |
| CO3--               | 0.00    | 0.00   | 0.00   | 0.00    | 0.13    |
| HCO3-               | 292.00  | 0.00   | 0.00   | 292.00  | 220.02  |
| SO4--               | 1303.00 | 0.00   | 0.00   | 1303.00 | 1359.66 |
| Cl-                 | 2364.00 | 0.00   | 0.00   | 2364.00 | 2364.00 |
| NO3-                | 7.68    | 0.00   | 0.00   | 7.68    | 7.68    |
| F-                  | 1.53    | 0.00   | 0.00   | 1.53    | 1.53    |
| SiO2                | 28.90   | 0.00   | 0.00   | 28.90   | 28.90   |
| CO2                 | 4.74    | 0.00   | 0.00   | 4.74    | 56.60   |
| Sum of Ions         | 6096.23 | 0.00   | 0.00   | 6096.23 | 6081.04 |
| TDS (180 C)         | 5947.65 | 0.00   | 0.00   | 5947.65 | 5969.09 |
| pH                  | 8.00    | 7.00   | 7.00   | 8.00    | 6.80    |
| Hardness (as CaCO3) | 2036.22 | 0.00   | 0.00   | 2036.22 | 2036.22 |
| Osm Pressure (Psig) | 51.62   | 0.00   | 0.00   | 51.62   | 51.35   |
| Langlier Index      | 1.76    | -7.00  | -7.00  | 1.76    | 0.43    |
| Stiff-Davis Index   | 1.32    | ---    | ---    | 1.32    | 0.00    |

Project: BVWSD  
 Prepared By: aeg

Description: Initial RO Projection  
 Type: Single Pass Design

BYPASS STREAM SUMMARY

| Stream Name      | Type         | Percent of Flow Rate Total | Stream Flow Rate (USGPM) | Temperature Design (Deg F) | Temperature Average (Deg F) |
|------------------|--------------|----------------------------|--------------------------|----------------------------|-----------------------------|
| 1A Feed 1 Bypass | Brackish Wel | ---                        | 0                        | 77.0                       | 77.0                        |
| 2A Feed 2 Bypass | Other        | ---                        | 0                        | 77.0                       | 77.0                        |
| 3A Feed 3 Bypass | Other        | ---                        | 0                        | 77.0                       | 77.0                        |
| 15 Feed Bypass   | Other        | ---                        | 0                        | 77.0                       | 77.0                        |

BYPASS STREAM COMPOSITIONS

| Stream Number       | 1A      | 2A     | 3A     | 15     |
|---------------------|---------|--------|--------|--------|
| Concentration       | (mg/L)  | (mg/L) | (mg/L) | (mg/L) |
| Ca++                | 675.00  | 0.00   | 0.00   | 0.00   |
| Mg++                | 85.13   | 0.00   | 0.00   | 0.00   |
| Na+                 | 1327.00 | 0.00   | 0.00   | 0.00   |
| K+                  | 4.07    | 0.00   | 0.00   | 0.00   |
| NH4+                | 0.10    | 0.00   | 0.00   | 0.00   |
| Sr++                | 6.22    | 0.00   | 0.00   | 0.00   |
| Ba++                | 0.15    | 0.00   | 0.00   | 0.00   |
| Fe++                | 0.45    | 0.00   | 0.00   | 0.00   |
| Mn++                | 1.00    | 0.00   | 0.00   | 0.00   |
| CO3--               | 0.00    | 0.00   | 0.00   | 0.00   |
| HCO3-               | 292.00  | 0.00   | 0.00   | 0.00   |
| SO4--               | 1303.00 | 0.00   | 0.00   | 0.00   |
| Cl-                 | 2364.00 | 0.00   | 0.00   | 0.00   |
| NO3-                | 7.68    | 0.00   | 0.00   | 0.00   |
| F-                  | 1.53    | 0.00   | 0.00   | 0.00   |
| SiO2                | 28.90   | 0.00   | 0.00   | 0.00   |
| CO2                 | 4.74    | 0.00   | 0.00   | 0.00   |
| Sum of Ions         | 6096.23 | 0.00   | 0.00   | 0.00   |
| TDS (180 C)         | 5947.65 | 0.00   | 0.00   | 0.00   |
| pH                  | 8.00    | 7.00   | 7.00   | 7.00   |
| Hardness (as CaCO3) | 2036.22 | 0.00   | 0.00   | 0.00   |
| Osm Pressure (Psig) | 51.62   | 0.00   | 0.00   | 0.00   |
| Langlier Index      | 1.76    | -7.00  | -7.00  | -7.00  |
| Stiff-Davis Index   | 1.32    | ---    | ---    | ---    |

Project: BVWSD  
 Prepared By: aeg

Description: Initial RO Projection  
 Type: Single Pass Design

PRODUCT STREAM SUMMARY

| Stream Name          | Stream Temperature   |                                   |
|----------------------|----------------------|-----------------------------------|
|                      | Flow Rate<br>(USGPM) | Design Average<br>(Deg F) (Deg F) |
| 13 Permeate          | 14                   | 77.0 77.0                         |
| 14 Stripped Permeate | 14                   | 77.0 77.0                         |
| 15 Feed Bypass       | 0                    | 77.0 77.0                         |
| 16 Blended Product   | 14                   | 77.0 77.0                         |
| 17 Treated Product   | 14                   | 77.0 77.0                         |

CHEMICAL ADDITION

No Chemical Treating

PRODUCT STREAM COMPOSITIONS

| Stream Number<br>Concentration | 13<br>(mg/L) | 14<br>(mg/L) | 15<br>(mg/L) | 16<br>(mg/L) | 17<br>(mg/L) |
|--------------------------------|--------------|--------------|--------------|--------------|--------------|
| Ca++                           | 11.12        | 11.12        | 0.00         | 11.12        | 11.12        |
| Mg++                           | 1.40         | 1.40         | 0.00         | 1.40         | 1.40         |
| Na+                            | 73.05        | 73.05        | 0.00         | 73.05        | 73.05        |
| K+                             | 0.28         | 0.28         | 0.00         | 0.28         | 0.28         |
| NH4+                           | 0.01         | 0.01         | 0.00         | 0.01         | 0.01         |
| Sr++                           | 0.10         | 0.10         | 0.00         | 0.10         | 0.10         |
| Ba++                           | 0.00         | 0.00         | 0.00         | 0.00         | 0.00         |
| Fe++                           | 0.01         | 0.01         | 0.00         | 0.01         | 0.01         |
| Mn++                           | 0.02         | 0.02         | 0.00         | 0.02         | 0.02         |
| CO3--                          | 0.00         | 0.00         | 0.00         | 0.00         | 0.00         |
| HCO3-                          | 18.04        | 18.04        | 0.00         | 18.04        | 18.04        |
| SO4--                          | 20.27        | 20.27        | 0.00         | 20.27        | 20.27        |
| Cl-                            | 110.63       | 110.63       | 0.00         | 110.63       | 110.63       |
| NO3-                           | 1.28         | 1.28         | 0.00         | 1.28         | 1.28         |
| F-                             | 0.04         | 0.04         | 0.00         | 0.04         | 0.04         |
| SiO2                           | 1.44         | 1.44         | 0.00         | 1.44         | 1.44         |
| CO2                            | 56.52        | 56.52        | 0.00         | 56.52        | 56.52        |
| Sum of Ions                    | 237.69       | 237.69       | 0.00         | 237.69       | 237.69       |
| TDS (180 C)                    | 228.51       | 228.51       | 0.00         | 228.51       | 228.51       |
| pH                             | 5.71         | 5.71         | 7.00         | 5.71         | 5.71         |
| Hardness (as CaCO3)            | 33.54        | 33.54        | 0.00         | 33.54        | 33.54        |
| Osm Pressure (Psig)            | 2.35         | 2.35         | 0.00         | 2.35         | 2.35         |
| Langlier Index                 | -3.65        | -3.65        | -7.00        | -3.65        | -3.65        |
| Stiff-Davis Index              | ---          | ---          | ---          | ---          | ---          |

KOCH Membrane Systems, Inc.

ROPRO Ver. 7.0-CP

Date: Dec-17-2003

Project: BVWSD  
Prepared By: aeg

Description: Initial RO Projection  
Type: Single Pass Design

ELEMENT BY ELEMENT DATA - PASS 1

| Bank | Element | Inlet Pressure (Psig) | Diff Pressure (Psig) | Element NDP (Psig) | Element Flux GFD | m Value | Beta  | Permeate TDS (mg/L) |
|------|---------|-----------------------|----------------------|--------------------|------------------|---------|-------|---------------------|
| 1    | 1       | 217.5                 | 3.3                  | 148.5              | 19.5             | -0.022  | 1.075 | 44.2                |
| 1    | 2       | 214.1                 | 2.8                  | 138.5              | 18.0             | -0.022  | 1.078 | 54.3                |
| 1    | 3       | 211.3                 | 2.4                  | 128.0              | 16.5             | -0.022  | 1.080 | 67.7                |
| 1    | 4       | 209.0                 | 2.0                  | 116.8              | 14.9             | -0.022  | 1.082 | 86.1                |
| 1    | 5       | 207.0                 | 1.6                  | 104.9              | 13.2             | -0.022  | 1.082 | 111.8               |
| 1    | 6       | 205.4                 | 1.4                  | 92.4               | 11.4             | -0.022  | 1.080 | 148.3               |
|      | Avg     |                       |                      | 121.5              | 15.6             | -0.022  | 1.079 | 85.4                |
| 2    | 1       | 204.0                 | 4.1                  | 90.9               | 17.9             | -0.022  | 1.072 | 316.4               |
| 2    | 2       | 200.0                 | 3.5                  | 77.4               | 14.8             | -0.022  | 1.066 | 433.2               |
| 2    | 3       | 196.5                 | 3.0                  | 65.4               | 12.1             | -0.022  | 1.059 | 594.1               |
| 2    | 4       | 193.4                 | 2.7                  | 55.3               | 9.8              | -0.021  | 1.052 | 808.6               |
| 2    | 5       | 190.8                 | 2.4                  | 47.2               | 7.9              | -0.021  | 1.045 | 1085.2              |
| 2    | 6       | 188.4                 | 2.2                  | 41.3               | 6.4              | -0.021  | 1.039 | 1424.1              |
|      | Avg     |                       |                      | 62.9               | 11.5             | -0.022  | 1.056 | 776.9               |

# **Appendix D – Year 2002 Filter Performance Data**



| Date      | Runtime (days) | Train | Filter Inlet Pressure (psi) | Filter Interstage Pressure (psi) | Filter Outlet Pressure (psi) | Filtrate SDI | Feed EC (mS/cm) | pH | Operational Notes                 |
|-----------|----------------|-------|-----------------------------|----------------------------------|------------------------------|--------------|-----------------|----|-----------------------------------|
| 3/25/2002 | -              | 2     | 68                          | -                                | -                            | 5.55         | 6.34            | -  | CIP                               |
| 3/28/2002 | -              | 2     | 40                          | -                                | 39                           | -            | -               | -  | Backwash                          |
| 4/1/2002  | 1              | 2     | 20                          | -                                | 19                           | 3.28         | 8.19            | -  | Adjusted Chem feed rates          |
| 4/2/2002  | 2              | 2     | 20                          | -                                | 19                           | 2.79         | 7.84            | -  | -                                 |
| 4/3/2002  | 3              | 2     | 21                          | -                                | 19                           | 2.44         | 7.57            | -  | -                                 |
| 4/4/2002  | 4              | 2     | 21                          | -                                | 19                           | 2.22         | 7.34            | -  | -                                 |
| 4/5/2002  | 5              | 2     | 20                          | -                                | 19                           | 2.26         | 7.14            | -  | -                                 |
| 4/6/2002  | 6              | 2     | -                           | -                                | -                            | -            | -               | -  | -                                 |
| 4/7/2002  | 7              | 2     | -                           | -                                | -                            | -            | -               | -  | -                                 |
| 4/08/02   | 8              | 2     | 20                          | -                                | 18                           | 2.22         | 6.94            | -  | -                                 |
| 4/9/2002  | 9              | 2     | 20                          | -                                | 18                           | 2.07         | 6.91            | -  | -                                 |
| 4/10/2002 | 10             | 1     | 20                          | -                                | 18                           | 1.93         | 7.97            | -  | Increased RO Recovery rate to 70% |
| 4/11/2002 | 11             | 1     | 20                          | -                                | 18                           | 1.84         | 7.78            | -  | -                                 |
| 4/12/2002 | 12             | 1     | 20                          | -                                | 18                           | 1.98         | 6.81            | -  | -                                 |

| Date      | Runtime (days) | Train | Filter Inlet Pressure (psi) | Filter Interstage Pressure (psi) | Filter Outlet Pressure (psi) | Filtrate SDI | Feed EC (mS/cm) | pH | Operational Notes   |
|-----------|----------------|-------|-----------------------------|----------------------------------|------------------------------|--------------|-----------------|----|---|
| 4/14/2002 | 14             | 1     | 20                          | -                                | 17                           | -            | -               | -  | -   |
| 4/15/02   | 15             | 2     | 20                          | -                                | 19                           | 2.42         | 6.72            | -  | Backwash  |
| 4/16/02   | 16             | 2     | 20                          | -                                | 18                           | 2.59         | 6.71            | -  | RO Membrane Cleaning  |
| 4/17/2002 | 17             | 2     | 20                          | 16                               | 18                           | 2.08         | 6.72            | -  | Initiated Alum Injection  |
| 4/18/2002 | 18             | 2     | 20                          | 16                               | 17                           | 1.88         | 6.68            | -  | -   |
| 4/19/2002 | 19             | 2     | 15                          | 14                               | 11                           | 1.77         | 6.66            | -  | -   |
| 4/20/2002 | 20             | 2     | -                           | -                                | -                            |              |                 |    | Plant Idled due to the lack of feed water - Electrical Problem w/ Well Pump |
| 4/21/2002 | 21             | 2     | -                           | -                                | -                            |              |                 |    | Plant Idled due to the lack of feed water - Electrical Problem w/ Well Pump |
| 4/22/2002 | 22             | 2     | -                           | -                                | -                            |              |                 |    | Plant Idled due to the lack of feed water - Electrical Problem w/ Well Pump |

| Date      | Runtime (days) | Train | Filter Inlet Pressure (psi) | Filter Interstage Pressure (psi) | Filter Outlet Pressure (psi) | Filtrate SDI | Feed EC (mS/cm) | pH | Operational Notes                   |
|-----------|----------------|-------|-----------------------------|----------------------------------|------------------------------|--------------|-----------------|----|-------------------------------------|
|           |                |       |                             |                                  |                              |              |                 |    |                                     |
| 4/23/2002 | 23             | 2     | 35                          | 36                               | 34                           | 2.75         | 7.21            | -  | <i>Prior to backwashing</i>         |
| 4/23/02   | 23             | 2     | 35                          | 34                               | 35                           | 2.31         | 7.19            | -  | Backwash                            |
| 4/24/2002 | 24             | 2     | 34                          | 35                               | 33                           | 2.11         | 6.84            | -  | -                                   |
| 4/25/2002 | 25             | 2     | 34                          | 33                               | 32                           | 1.96         | 6.82            | -  | -                                   |
| 4/26/2002 | 26             | 2     | 25                          | 27                               | 24                           | 3.43         | 6.68            | -  | Added Well #2 as a Feedwater source |
| 4/27/2002 | 27             | 2     | 26                          | 24                               | 22                           | 1.62         | 6.78            | -  | -                                   |
| 4/28/2002 | 28             | 2     | -                           | -                                | -                            | -            | -               | -  | -                                   |
| 4/29/2002 | 29             | 2     | 26                          | 15                               | 12                           | 1.78         | 6.74            | -  | <i>Prior to backwashing</i>         |
| 4/29/02   | 29             | 2     | 26                          | 27                               | 26                           | 1.85         | 6.69            | -  | Backwash waste fluid turned red     |
| 4/30/2002 | 30             | 2     | 26                          | 28                               | 25                           | 1.70         | 6.74            | -  | -                                   |
| 5/1/2002  | 31             | 2     | 26                          | 26                               | 24                           | 2.06         | 6.72            | -  | -                                   |
| 5/2/2002  | 32             | 2     | 26                          | 24                               | 22                           | 1.90         | 6.71            | -  | -                                   |

| Date      | Runtime (days) | Train | Filter Inlet Pressure (psi) | Filter Interstage Pressure (psi) | Filter Outlet Pressure (psi) | Filtrate SDI | Feed EC (mS/cm) | pH | Operational Notes                 |
|-----------|----------------|-------|-----------------------------|----------------------------------|------------------------------|--------------|-----------------|----|-----------------------------------|
| 5/3/2002  | 33             | 2     | 27                          | 28                               | 25                           | 2.27         | 6.60            | -  | -                                 |
| 5/4/2002  | 34             | 2     | -                           | -                                | -                            | -            | -               | -  | -                                 |
| 5/5/2002  | 35             | 2     | -                           | -                                | -                            | -            | -               | -  | -                                 |
| 5/6/2002  | 36             | 2     | 26                          | 16                               | 13                           |              | 6.67            | -  | <i>Prior to backwashing</i>       |
| 5/06/02   | 36             | 2     | 28                          | 28                               | 27                           | 1.85         | 6.67            | -  | Backwash                          |
| 5/7/2002  | 37             | 2     | 27                          | 28                               | 26                           | 2.11         | 6.67            | -  | Switch from Alum to FeCl3         |
| 5/8/2002  | 38             | 2     | 27                          | 28                               | 24                           | 5.70         | 6.65            | -  | <i>Prior to backwashing</i>       |
| 5/8/2002  | 38             | 2     | 27                          | 28                               | 27                           | 1.90         | 6.65            | -  | Backwash                          |
| 5/9/2002  | 39             | 2     | 27                          | 28                               | 27                           | 2.16         | 6.64            | -  | Stopped using FeCl3               |
| 5/10/2002 | 40             | 2     | 27                          | 28                               | 27                           | 2.01         | 6.63            | -  | No Coagulant                      |
| 5/11/2002 | 41             | 2     | -                           | -                                | -                            | -            | -               | -  | No Coagulant                      |
| 5/12/2002 | 42             | 2     | -                           | -                                | -                            | -            | -               | -  | No Coagulant                      |
| 5/13/2002 | 43             | 2     | 27                          | 28                               | 26                           | 1.89         | 6.61            | -  | <i>Prior to Membrane cleaning</i> |
| 5/13/02   | 43             | 2     | 27                          | 28                               | 26                           | 1.48         | 6.39            | -  | Membrane Cleaning & Backwash      |



| Date    | Runtime (days) | Train | Filter Inlet Pressure (psi) | Filter Interstage Pressure (psi) | Filter Outlet Pressure (psi) | Filtrate SDI | Feed EC (mS/cm) | pH   | Operational Notes                   |
|---------|----------------|-------|-----------------------------|----------------------------------|------------------------------|--------------|-----------------|------|-------------------------------------|
|         |                |       |                             |                                  |                              |              |                 |      |                                     |
| 5/28/02 | 58             | 2     | 27                          | 13                               | 12                           | 1.62         | 6.58            | 7.23 | Backwash                            |
| 5/29/02 | 59             | 2     | 27                          | 27                               | 24                           | 1.94         | 6.59            | 6.48 | -                                   |
| 5/30/02 | 60             | 2     | 27                          | 25                               | 21                           | 1.92         | 6.58            | 8.54 | -                                   |
| 5/31/02 | 61             | 2     | 27                          | 22                               | 22                           | 1.92         | 6.49            | 8.95 | -                                   |
| 6/01/02 | 62             | 2     | -                           | -                                | -                            | -            | -               | -    | -                                   |
| 6/02/02 | 63             | 2     | -                           | -                                | -                            | -            | -               | -    | -                                   |
| 6/03/02 | 64             | 2     | 27                          | 9                                | 3                            | 1.57         | 6.60            | 6.33 | Installed new pH & Temp probe       |
| 6/04/02 | 65             | 2     | 27                          | 26                               | 25                           |              | 6.62            | 7.15 | Backwash filters; Irrigation season |
| 6/05/02 | 66             | 2     | 27                          | 23                               | 22                           | 2.00         | 6.62            | 9.09 | -                                   |
| 6/06/02 | 67             | 2     | 26                          | 20                               | 19                           | 1.85         | 6.63            | 8.52 | -                                   |
| 6/07/02 | 68             | 2     | 26                          | 18                               | 16                           | 1.75         | 6.63            | 6.83 | Backwash filters                    |
| 6/08/02 | 69             | 2     | -                           | -                                | -                            | -            | -               | -    | -                                   |







| Date      | Runtime (days) | Train | Filter Inlet Pressure (psi) | Filter Interstage Pressure (psi) | Filter Outlet Pressure (psi) | Filtrate SDI | Feed EC (mS/cm) | pH   | Operational Notes  |
|-----------|----------------|-------|-----------------------------|----------------------------------|------------------------------|--------------|-----------------|------|--|
| 7/5/2002  | 96             | 2     | 27                          | 19                               | 18                           | 1.92         | 6.691           | 5.81 | Backwashed filters after these readings: 35 min for vessel C, 20 min for vessel D; dark orange |
| 7/6/2002  | 97             | 2     |                             |                                  |                              |              |                 |      | -  |
| 7/7/2002  | 98             | 2     |                             |                                  |                              |              |                 |      | -  |
| 7/8/2002  | 99             | 2     | 26                          | 21                               | 22                           | 2.04         | 6.710           | 5.72 | Alum pump failed over the weekend  |
| 7/9/2002  | 100            | 2     | 26                          | 23                               | 22                           | 1.92         | 6.712           | 5.72 | -  |
| 7/10/2002 | 101            | 2     | 15                          | 10                               | 8                            | 1.26         | 6.597           | 5.70 | -  |
| 7/11/2002 | 102            | 2     | 27                          | 19                               | 18                           | 1.61         | 6.713           | 5.78 | -  |
| 7/12/2002 | 103            | 2     | 27                          | 17                               | 15                           | 1.87         | 6.716           | 5.79 | Backwashed filters after these readings: 15 min for vessel C, 20 min for vessel D; dark orange |
| 7/13/2002 | 104            | 2     |                             |                                  |                              |              |                 |      | -  |

| Date      | Runtime (days) | Train | Filter Inlet Pressure (psi) | Filter Interstage Pressure (psi) | Filter Outlet Pressure (psi) | Filtrate SDI | Feed EC (mS/cm) | pH   | Operational Notes  |
|-----------|----------------|-------|-----------------------------|----------------------------------|------------------------------|--------------|-----------------|------|--|
| 7/14/2002 | 105            | 2     |                             |                                  |                              |              |                 |      | -  |
| 7/15/2002 | 106            | 2     | 27                          | 24                               | 23                           | 1.92         | 6.676           | 5.86 | -  |
| 7/16/2002 | 107            | 2     | 27                          | 22                               | 22                           | 1.92         | 6.680           | 5.86 | Replace Alum Pump; recalibrated pH probe   |
| 7/17/2002 | 108            | 2     | 27                          | 17                               | 15                           | 2.33         | 6.685           | 6.63 | -  |
| 7/18/2002 | 109            | 2     | 26                          | 13                               | 12                           | 2.10         | 6.704           | 6.62 | -  |
| 7/19/2002 | 110            | 2     | 26                          | 7                                | 2                            | 1.99         | 6.715           | 6.63 | Backwashed filters after these readings: 20 min for vessel C, 20 min for vessel D; dark orange |
| 7/20/2002 | 111            |       |                             |                                  |                              |              |                 |      | -  |
| 7/21/2002 | 112            |       |                             |                                  |                              |              |                 |      | -  |
| 7/22/2002 | 113            | 2     | 26                          | 13                               | 16                           | 1.90         | 6.729           | 6.62 | Increase Recovery  |
| 7/23/2002 | 114            | 2     | 26                          | 10                               | 8                            | 2.22         | 6.741           | 6.61 | Backwash   |
| 7/24/2002 | 115            | 2     | 26                          | 25                               | 24                           | 1.82         | 6.748           | 6.63 | -  |
| 7/25/2002 | 116            | 2     | 26                          | 23                               | 22                           | 1.87         | 6.755           | 6.63 | -  |

| Date      | Runtime (days) | Train | Filter Inlet Pressure (psi) | Filter Interstage Pressure (psi) | Filter Outlet Pressure (psi) | Filtrate SDI | Feed EC (mS/cm) | pH   | Operational Notes  |
|-----------|----------------|-------|-----------------------------|----------------------------------|------------------------------|--------------|-----------------|------|--|
| 7/26/2002 | 117            | 2     | 27                          | 21                               | 20                           | 2.29         | 6.441           | 6.63 | -  |
| 7/27/2002 | 118            |       |                             |                                  |                              |              |                 |      | -  |
| 7/28/2002 | 119            |       |                             |                                  |                              |              |                 |      | -  |
| 7/29/2002 | 120            | 2     | 26                          | 14                               | 12                           | 1.82         | 6.726           | 6.60 | Backwashed filters after these readings: 20 min for vessel C - dark orange, 10 min for vessel D - light orange |
| 7/30/2002 | 121            | 2     | 27                          | 20                               | 19                           | 2.08         | 6.720           | 6.71 | -  |
| 7/31/2002 | 122            | 2     | 27                          | 19                               | 16                           | 2.08         | 6.719           | 6.69 | -  |
| 8/1/2002  | 123            | 2     | 27                          | 17                               | 14                           | 1.67         | 6.713           | 6.70 | -  |
| 8/2/2002  | 124            | 2     | 27                          | 11                               | 10                           | 2.08         | 6.714           | 6.70 | Backwash   |
| 8/3/2002  | 125            |       |                             |                                  |                              |              |                 |      | -  |
| 8/4/2002  | 126            |       |                             |                                  |                              |              |                 |      | -  |
| 8/5/2002  | 127            | 2     | 27                          | 18                               | 16                           | 0.83         | 6.718           | 6.71 | Before CIP   |
| 8/5/2002  | 127            | 2     | 27                          | 28                               | 25                           |              | 6.660           | 7.17 | After Backwash & CIP   |

| Date      | Runtime (days) | Train | Filter Inlet Pressure (psi) | Filter Interstage Pressure (psi) | Filter Outlet Pressure (psi) | Filtrate SDI | Feed EC (mS/cm) | pH   | Operational Notes   |
|-----------|----------------|-------|-----------------------------|----------------------------------|------------------------------|--------------|-----------------|------|---|
| 8/5/2002  | 127            | 2     | 27                          | 28                               | 25                           |              | 6.670           | 7.16 | After CIP   |
| 8/6/2002  | 128            | 2     | 27                          | 26                               | 23                           | 1.88         | 6.707           | 6.51 | -   |
| 8/7/2002  | 129            | 2     | 27                          | 22                               | 20                           | 1.51         | 6.707           | 6.44 | -   |
| 8/8/2002  | 130            | 2     | 27                          | 19                               | 18                           | 1.88         | 6.730           | 6.40 | -   |
| 8/9/2002  | 131            | 2     | 27                          | 16                               | 15                           | 2.42         | 6.736           | 6.40 | Power shut off for a day due to nearby construction; data logger off for the entire weekend |
| 8/10/2002 | 132            | 2     |                             |                                  |                              |              |                 |      | -   |
| 8/11/2002 | 133            | 2     |                             |                                  |                              |              |                 |      | -   |
| 8/12/2002 | 134            | 2     | 27                          | 21                               | 20                           | 2.08         | 6.737           | 6.66 | Irrigation Season ends this week  |
| 8/13/2002 | 135            | 2     | 27                          | 15                               | 12                           | 2.08         | 6.731           | 6.54 | -   |
| 8/14/2002 | 136            | 2     | 27                          | 14                               | 12                           | 1.81         | 6.736           | 6.53 | Backwash; 20 min/20 min   |
| 8/15/2002 | 137            | 2     | 27                          | 25                               | 24                           | 1.77         | 6.729           | 6.51 | -   |
| 8/16/2002 | 138            | 2     | 27                          | 23                               | 22                           | 2.28         | 6.736           | 6.49 | -   |

| Date      | Runtime (days) | Train | Filter Inlet Pressure (psi) | Filter Interstage Pressure (psi) | Filter Outlet Pressure (psi) | Filtrate SDI | Feed EC (mS/cm) | pH   | Operational Notes  |
|-----------|----------------|-------|-----------------------------|----------------------------------|------------------------------|--------------|-----------------|------|--|
| 8/17/2002 | 139            |       |                             |                                  |                              |              |                 |      | -  |
| 8/18/2002 | 140            |       |                             |                                  |                              |              |                 |      | -  |
| 8/19/2002 | 141            | 2     | 26                          | 17                               | 15                           | 1.46         | 6.743           | 6.46 | -  |
| 8/20/2002 | 142            | 2     | 26                          | 16                               | 14                           | 1.46         | 6.750           | 6.48 | Backwashed 30 min on the first, 14 min on the second (water ran out on the second) |
| 8/21/2002 | 143            | 2     |                             |                                  |                              |              |                 |      | -  |
| 8/22/2002 | 144            | 2     |                             |                                  |                              |              |                 |      | -  |
| 8/23/2002 | 145            | 2     | 27                          | 21                               | 20                           | 2.22         | 6.736           | 6.55 | -  |
| 8/24/2002 | 146            |       |                             |                                  |                              |              |                 |      | -  |
| 8/25/2002 | 147            |       |                             |                                  |                              |              |                 |      | -  |
| 8/26/2002 | 148            | 1     | 27                          | 17                               | 14                           | 1.98         | 6.738           | 6.50 | -  |
| 8/27/2002 | 149            | 1     | 27                          | 28                               | 26                           | 1.81         | 6.738           | 6.52 | -  |
| 8/28/2002 | 150            | 1     | 27                          | 27                               | 25                           | 1.87         | 6.749           | 6.50 | -  |
| 8/29/2002 | 151            | 1     | 38                          | 36                               | 34                           | 1.67         | 5.634           | 6.45 | Increased Inflow   |

| Date      | Runtime (days) | Train | Filter Inlet Pressure (psi) | Filter Interstage Pressure (psi) | Filter Outlet Pressure (psi) | Filtrate SDI | Feed EC (mS/cm) | pH   | Operational Notes   |
|-----------|----------------|-------|-----------------------------|----------------------------------|------------------------------|--------------|-----------------|------|---|
| 8/30/2002 | 152            | 1/2   | 38                          | 33                               | 29                           | 1.67         | 5.605           | 6.45 | Switched from Train 1 to Train 2; backwashed Train 1                          |
| 9/3/2002  | 154            | 2     | 39                          | 33                               | 33                           | 1.73         | 5.427           | 6.40 | Backwashed Train 2 C and D and then shut plant down due to low RO pressures   |
| 9/11/2002 | 162            | 2     | 38                          | 38.5                             | 38                           |              | 5.867           | 6.76 | Train 1 was left in recycle; top washed Train 2 and left Train 2 in operation |
| 9/13/2002 | 164            | 2     | 39                          | 39                               | 39                           | 1.38         | 5.405           | 6.41 | -   |
| 9/16/2002 | 167            | 2     | 39                          | 39                               | 39                           | 1.38         | 5.387           | 6.42 | -   |
| 9/17/2002 | 168            | 2     | 39                          | 39                               | 39                           | 1.90         | 5.384           | 6.38 | -   |
| 9/18/2002 | 169            | 2     | 39                          | 39                               | 40                           | 1.38         | 5.386           | 6.38 | -   |
| 9/19/2002 | 170            | 2     | 39                          | 39                               | 40                           | 1.38         | 5.378           | 6.41 | -   |
| 9/20/2002 | 171            | 2     | 39                          | 39                               | 40                           | 1.33         | 5.376           | 6.40 | Backwashed Train 2 C and D and turned on booster pump.                        |

| Date      | Runtime (days) | Train | Filter Inlet Pressure (psi) | Filter Interstage Pressure (psi) | Filter Outlet Pressure (psi) | Filtrate SDI | Feed EC (mS/cm) | pH   | Operational Notes  |
|-----------|----------------|-------|-----------------------------|----------------------------------|------------------------------|--------------|-----------------|------|--|
| 9/23/2002 | 174            | 2     | 38                          | 37                               | 36                           | 1.90         | 6.332           | 6.59 | Found unit off   |
| 9/24/2002 | 175            | 2     | 38                          | 36                               | 35                           | 1.90         | 6.262           | 6.64 | -  |
| 9/25/2002 | 176            | 2     | 38                          | 35                               | 34                           | 1.44         | 6.305           | 6.63 | -  |
| 9/26/2002 | 177            | 2     | 38                          | 33                               | 33                           | 1.54         | 6.294           | 6.62 | -  |
| 9/27/2002 | 178            | 2     | 38                          | 32                               | 33                           | 1.46         | 6.319           | 6.60 | -  |
| 9/30/2002 | 181            | 2     | 38                          | 30                               | 29                           | 1.75         | 6.290           | 6.79 | Found unit off/Operator backwashed Train 2 vessels C & D |
| 10/1/2002 | 182            | 2     | 38                          | 39                               | 38                           | 1.78         | 6.508           | 6.57 | -  |
| 10/2/2002 | 183            | 2     | 38                          | 39                               | 38                           | 1.50         | 6.555           | 6.57 | -  |
| 10/3/2002 | 184            | 2     | 38                          | 37                               | 37                           | 1.96         | 6.620           | 6.55 | -  |
| 10/4/2002 | 185            | 2     | 38                          | 36                               | 35                           | 2.09         | 6.559           | 6.92 | -  |
| 10/7/2002 | 188            | 2     | 38                          | 29                               | 29                           | 1.71         | 6.349           | 6.94 | Backwashed Train 2 and did a top wash.                   |
| 10/8/2002 | 189            | 2     | 38                          | 39                               | 39                           | 2.15         | 6.580           | 6.93 | -  |









| Date       | Runtime (days) | Train | Filter Inlet Pressure (psi) | Filter Interstage Pressure (psi) | Filter Outlet Pressure (psi) | Filtrate SDI | Feed EC (mS/cm) | pH   | Operational Notes   |
|------------|----------------|-------|-----------------------------|----------------------------------|------------------------------|--------------|-----------------|------|---|
| 11/11/2002 | 223            | 1     | 37                          | 35                               | 34                           | 2.16         | 6.478           | 5.77 | Recalibrated pH probe; operators backwashed Train #1 Vessel A & B |
| 11/12/2002 | 224            | 1     | 37                          | 37                               | 37                           | 2.22         | 6.513           | 6.51 | -   |
| 11/13/2002 | 225            | 1     | 37                          | 37                               | 36                           | 2.22         | 6.460           | 6.17 | -   |
| 11/14/2002 | 226            | 1     | 37                          | 37                               | 35                           | 2.28         | 6.444           | 6.19 | Changed acid from 50/50 to 40/40                                  |
| 11/15/2002 | 227            | 1     | 37                          | 37                               | 35                           | 2.16         | 6.443           | 6.16 | Changed acid back to 50/50  |
| 11/18/2002 | 230            | 1     | 37                          | 35                               | 34                           | 2.22         | 6.391           | 6.21 | Backwashed Train 1, Vessels A & B                                 |
| 11/19/2002 | 231            | 1     | 37                          | 37                               | 36                           | 2.28         | 6.504           | 6.60 | -   |
| 11/20/2002 | 232            | 1     | 37                          | 37                               | 36                           | 2.39         | 6.475           | 6.50 | -   |
| 11/21/2002 | 233            | 1     | 37                          | 37                               | 35                           | 2.16         | 6.463           | 6.28 | -   |
| 11/22/2002 | 234            | 1     | 37                          | 36                               | 35                           | 2.10         | 6.466           | 6.54 | -   |
| 11/25/2002 | 237            | 1     | 37                          | 35                               | 34                           | 2.44         | 4.124           | 6.06 | Backwashed Train #1   |

| Date       | Runtime (days) | Train | Filter Inlet Pressure (psi) | Filter Interstage Pressure (psi) | Filter Outlet Pressure (psi) | Filtrate SDI | Feed EC (mS/cm) | pH   | Operational Notes   |
|------------|----------------|-------|-----------------------------|----------------------------------|------------------------------|--------------|-----------------|------|---------------------|
| 11/26/2002 | 238            | 1     | 37                          | 37                               | 36                           | 2.28         | 6.601           | 6.35 | -                   |
| 11/27/2002 | 239            | 1     | 37                          | 37                               | 36                           | 2.34         | 6.578           | 6.12 | -                   |
| 11/29/2002 | 241            | 1     | 37                          | 36                               | 35                           | 2.28         | 6.521           | 6.25 | -                   |
| 12/2/2002  | 242            | 1     | 37                          | 35                               | 33                           | 1.62         | 6.367           | 6.30 | Backwashed Train #1 |
| 12/3/2002  | 243            | 1     | 37                          | 37                               | 36                           | 2.34         | 6.512           | 6.08 | -                   |